

## Preise und Zuschläge

Die aufgeführten Preise in der Preisliste verstehen sich per Meter netto.  
Zuschnitte und Rahmen werden nach dem Tarif berechnet.

## Muster

Auf Anfrage stellen wir Ihnen gerne Musterstücke à 25 cm oder Musterwinkel à 17 x 17 cm zur Verfügung.

## Mengenrabatte

ab 18 m	5% Rabatt
ab 36 m	8% Rabatt
ab 60 m	10% Rabatt
ab 120 m	12% Rabatt

Diese % gelten pro Nummer und Breite in der gleichen Holzart.

## Qualität

Die übliche Stablänge liegt zwischen 2 und 3 m.  
Bedenken Sie, dass Naturhölzer lebendige und ungleichmässige Strukturen aufweisen können, welche die Schönheit der Natur ausmachen. Geringe Farb- und Strukturunterschiede, wie z.B. Spiegel bei Eiche oder Riegel bei Ahorn, sind naturgegeben und zu akzeptieren. Für Rahmen wählen wir möglichst homogene Schenkel.

## Wth B

Gezinkt, eignet sich zum Grundieren, Vergolden, zum deckend Bearbeiten, so dass die Zinkung unsichtbar ist.  
Leistenlänge 3 Meter

## Rohleisten Extraanfertigungen / Kehlmesser

Für das Anfertigen von Kehlmessern für Extraprofile verrechnen wir den effektiven Aufwand. Das Material (Stahl) stellen wir kostenlos zur Verfügung. Die Kehlmesser bleiben in unserem Besitze, diese können in keinem Fall vom Kunden angefordert werden.

Mindestbezug für Extraanfertigungen: 60 m.

## Grundierte Leisten

Eignen sich zum Vergolden, Lackieren, etc. Leistenlänge 3 m

## FSC®-zertifiziert



Das Forest Stewardship Council® ist eine internationale Nicht-Regierungsorganisation, die weltweit eine umweltfreundliche, sozial gerechte und wirtschaftlich tragfähige Bewirtschaftung der Wälder fördert. Für weitere Informationen besuchen Sie [www.fsc.org](http://www.fsc.org).

Der FSC setzt sich weltweit für die Förderung nachhaltiger Forstwirtschaft ein.

FSC hilft Wälder für zukünftige Generationen zu erhalten.

Der FSC hilft Wälder zu erhalten und schützt die Interessen von Menschen und die Tiere, die in oder von diesen Wäldern leben.

## Herkunft Rohhölzer

Ahorn	Schweiz
Eiche	USA, EU
Fichte	Schweiz
Weymouthsföhre	Schweiz
Kirschbaum	Schweiz, Frankreich, Kroatien, USA
Linde	Ungarn
Nussbaum	Nordamerika



## Weymouthsföhre (Wth B)

Leisten sind keilgezinkt eignen sich zum Grundieren und Vergolden

FSC®-zertifiziert



## Weymouthsföhre (Wth A)

eignen sich zum Grundieren und Vergolden

FSC®-zertifiziert

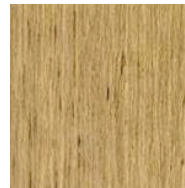

## Eiche

Struktur: gefladert, gestreift, mit auffälligen Markstrahlen, glänzend, sehr dekorativ

FSC®-zertifiziert

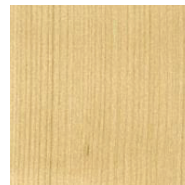

## Ahorn

Struktur: schlicht, schwach gefladert/gestreift, gewellt, gemasert, seidig glänzend, sehr dekorativ

FSC®-zertifiziert

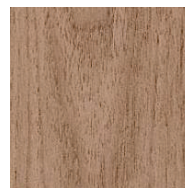

## Nussbaum

Struktur: gefladert, glänzend, sehr dekorativ

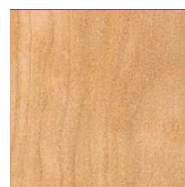

## Kirschbaum

Struktur: gefladert, gestreift, geflammt, gemasert, glänzend, sehr dekorativ

FSC®-zertifiziert

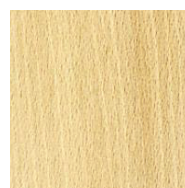

## Fichte

Struktur: gefladert, gestreift, schwach glänzend, wenig dekorativ









FSC®-zertifiziert









## Linde

Struktur: schlicht

FSC®-zertifiziert

Profilschnitt	Art-Nr.	Bezeichnung	Holzart	CHF/m	Tarif-Nr.
Falzleisten					
	09731	<b>1339</b> -4/6	Wth B		140
	09732	<b>1339</b> -4/8	Wth B		140
	09733	<b>1339</b> -6/8	Wth B		140
	09734	<b>1339</b> -5/10	Wth B		140
	09735	<b>1339</b> -8/10	Wth B		140
	09736	<b>1339</b> -10/12	Wth B		140
	09737	<b>1339</b> -12/15	Wth B		140
	09736	<b>1339</b> -10/20	Wth B		140
	09746	<b>1339</b> -15/25	Wth B		150

Profilschnitt	Art-Nr.	Bezeichnung	Holzart	CHF/m	Tarif-Nr.
<b>Distanzleisten</b>					
	55807	<b>7030</b> -4/10	Linde	130	
	55808	<b>7030</b> -4/10	Fichte	130	
	55809	<b>7030</b> -4/10	Ahorn	140	
	55810	<b>7030</b> -4/10	Eiche	140	
	55811	<b>7030</b> -4/10	Nussbaum	160	
	55812	<b>7030</b> -4/10	Kirschbaum	150	
	55305	<b>7030</b> -5/5	Linde	130	
	09826	<b>7030</b> -5/5	Fichte	130	
	09827	<b>7030</b> -5/5	Ahorn	140	
	09828	<b>7030</b> -5/5	Eiche	140	
	55829	<b>7030</b> -5/5	Nussbaum	160	
	55830	<b>7030</b> -5/5	Kirschbaum	150	
	55306	<b>7030</b> -5/10	Linde	130	
	09829	<b>7030</b> -5/10	Fichte	130	
	09836	<b>7030</b> -5/10	Ahorn	140	
	53066	<b>7030</b> -5/10	Eiche	140	
	55835	<b>7030</b> -5/10	Nussbaum	160	
	5836	<b>7030</b> -5/10	Kirschbaum	150	
	55307	<b>7030</b> -5/15	Linde	140	
	09838	<b>7030</b> -5/15	Fichte	130	
	09840	<b>7030</b> -5/15	Ahorn	150	
	09839	<b>7030</b> -5/15	Eiche	140	
	55841	<b>7030</b> -5/15	Nussbaum	170	
	55842	<b>7030</b> -5/15	Kirschbaum	170	
	55308	<b>7030</b> -5/20	Linde	140	
	09841	<b>7030</b> -5/20	Fichte	140	
	09843	<b>7030</b> -5/20	Ahorn	150	
	09842	<b>7030</b> -5/20	Eiche	150	
	55847	<b>7030</b> -5/20	Nussbaum	180	
	55848	<b>7030</b> -5/20	Kirschbaum	170	
	55309	<b>7030</b> -5/25	Linde	140	
	09844	<b>7030</b> -5/25	Fichte	140	
	09846	<b>7030</b> -5/25	Ahorn	150	
	09845	<b>7030</b> -5/25	Eiche	150	
	55853	<b>7030</b> -5/25	Nussbaum	190	
	55854	<b>7030</b> -5/25	Kirschbaum	180	



# ROHLEISTEN / MASCHINENGRUNDIERTE LEISTEN

Profilschnitt	Art-Nr.	Bezeichnung	Holzart	CHF/m	Tarif-Nr.
	55310	<b>7030</b> -5/30	Linde		140
	09847	<b>7030</b> -5/30	Fichte		140
	09849	<b>7030</b> -5/30	Ahorn		160
	09848	<b>7030</b> -5/30	Eiche		160
	55859	<b>7030</b> -5/30	Nussbaum		1100
	55860	<b>7030</b> -5/30	Kirschbaum		190
	55312	<b>7030</b> -5/40	Linde		150
	09853	<b>7030</b> -5/40	Fichte		150
	09855	<b>7030</b> -5/40	Ahorn		170
	09854	<b>7030</b> -5/40	Eiche		170
	55871	<b>7030</b> -5/40	Nussbaum		1120
	55872	<b>7030</b> -5/40	Kirschbaum		1110
	22643	<b>7030</b> -7/25	Linde		150
	22644	<b>7030</b> -7/25	Fichte		150
	22645	<b>7030</b> -7/25	Ahorn		170
	22646	<b>7030</b> -7/25	Eiche		160
	22647	<b>7030</b> -7/25	Nussbaum		1110
	22648	<b>7030</b> -7/25	Kirschbaum		1100
	22649	<b>7030</b> -7/35	Linde		160
	22650	<b>7030</b> -7/35	Fichte		150
	22651	<b>7030</b> -7/35	Ahorn		180
	22652	<b>7030</b> -7/35	Eiche		170
	22653	<b>7030</b> -7/35	Nussbaum		1130
	22654	<b>7030</b> -7/35	Kirschbaum		1120
	22655	<b>7030</b> -7/50	Linde		170
	22656	<b>7030</b> -7/50	Fichte		160
	22657	<b>7030</b> -7/60	Linde		1100

Profilschnitt	Art-Nr.	Bezeichnung	Holzart	CHF/m	Tarif-Nr.
---------------	---------	-------------	---------	-------	-----------

## Keilrahmenprofil

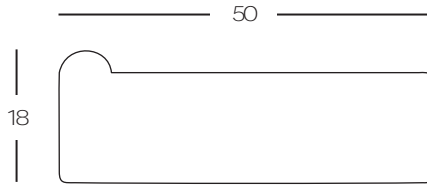

07920 **1340** -50/18 Fichte

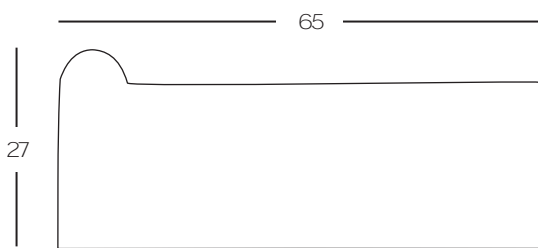

53170 **1340** -65/27 Fichte

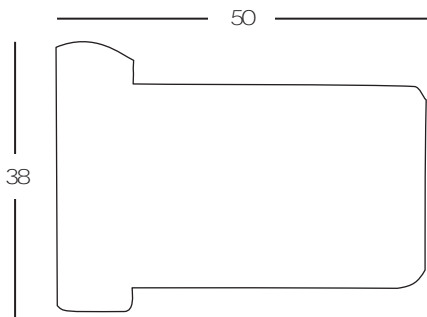

07921 **1340** -50/38 Fichte

## Querstreben für Keilrahmen

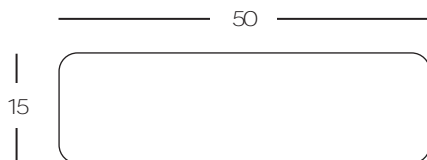

53171 **1330** -50/15 Fichte

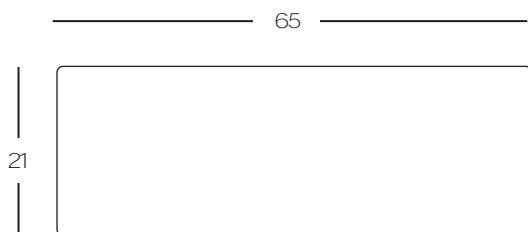

53172 **1330** -65/21 Fichte

Profilschnitt	Art-Nr.	Bezeichnung	Holzart	CHF/m	Tarif-Nr.
---------------	---------	-------------	---------	-------	-----------

## Verstärkungsleisten / Aufhängeleisten

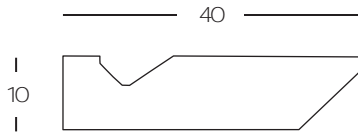

09116	<b>40</b> -10AL	Tulipwood	470
-------	-----------------	-----------	-----

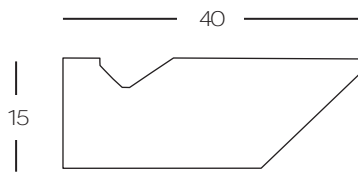

09117	<b>40</b> -15AL	Tulipwood	4100
-------	-----------------	-----------	------

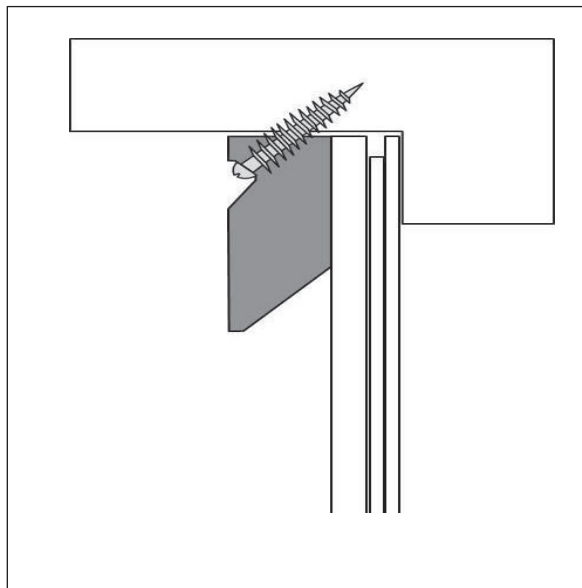

Profilschnitt	Art-Nr.	Bezeichnung	Holzart	CHF/m	Tarif-Nr.
---------------	---------	-------------	---------	-------	-----------

## Kastenprofile

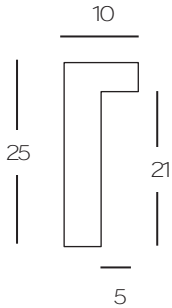

11263	<b>10 -25 KC</b>	Wth A	190
11235	<b>10 -25 KC</b>	Fichte	190
30737	<b>10 -25 KC</b>	Linde	1100
30731	<b>10 -25 KC</b>	Ahorn	1120
30743	<b>10 -25 KC</b>	Eiche	1130
11246	<b>10 -25 KC</b>	Nussbaum	1170
30753	<b>10 -25 KC</b>	Kirschbaum	1170

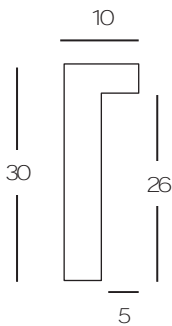

08850	<b>10 -30 KC</b>	Wth A	1100
11236	<b>10 -30 KC</b>	Fichte	1100
30738	<b>10 -30 KC</b>	Linde	1100
11204	<b>10 -30 KC</b>	Ahorn	1150
30744	<b>10 -30 KC</b>	Eiche	1150
30754	<b>10 -30 KC</b>	Kirschbaum	1230
11247	<b>10 -30 KC</b>	Nussbaum	1230

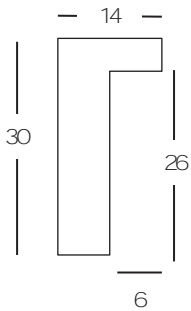

08858	<b>14 -30 KC</b>	Wth A	2100
11238	<b>14 -30 KC</b>	Fichte	2100
30739	<b>14 -30 KC</b>	Linde	2110
11205	<b>14 -30 KC</b>	Ahorn	2170
30745	<b>14 -30 KC</b>	Eiche	2170
11249	<b>14 -30 KC</b>	Nussbaum	2270
30761	<b>14 -30 KC</b>	Kirschbaum	2270

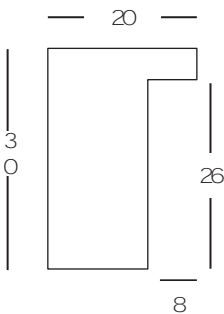

08995	<b>20 -30 KC</b>	Wth A	2120
30779	<b>20 -30 KC</b>	Fichte	2120
30777	<b>20 -30 KC</b>	Linde	2120
30776	<b>20 -30 KC</b>	Ahorn	2180
30778	<b>20 -30 KC</b>	Eiche	2220
30780	<b>20 -30 KC</b>	Nussbaum	2290
30781	<b>20 -30 KC</b>	Kirschbaum	2290

Profilschnitt	Art-Nr.	Bezeichnung	Holzart	CHF/m	Tarif-Nr.
---------------	---------	-------------	---------	-------	-----------

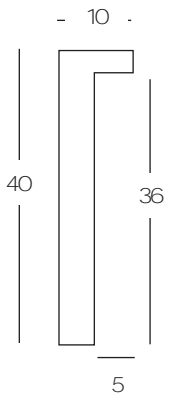

11239	<b>10</b> -40 KC	Fichte	1110
30740	<b>10</b> -40 KC	Linde	1120
30734	<b>10</b> -40 KC	Ahorn	1170
30746	<b>10</b> -40 KC	Eiche	1180
11250	<b>10</b> -40 KC	Nussbaum	1250
30755	<b>10</b> -40 KC	Kirschbaum	1250

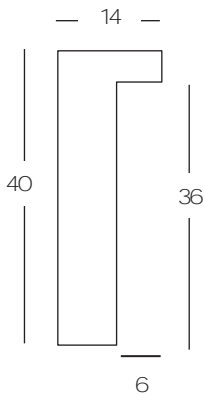

11241	<b>14</b> -40 KC	Fichte	2120
30742	<b>14</b> -40 KC	Linde	2120
30736	<b>14</b> -40 KC	Ahorn	2190
30748	<b>14</b> -40 KC	Eiche	2200
11252	<b>14</b> -40 KC	Nussbaum	2270
30762	<b>14</b> -40 KC	Kirschbaum	2270

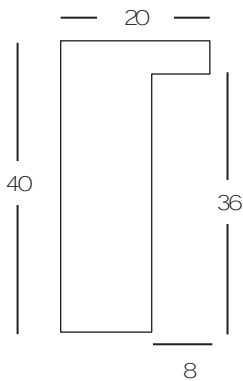

08861	<b>20</b> -40 KC	Wth A	2130
11258	<b>20</b> -40 KC	Fichte	2130
11256	<b>20</b> -40 KC	Linde	2140
11255	<b>20</b> -40 KC	Ahorn	2210
11257	<b>20</b> -40 KC	Eiche	2220
11259	<b>20</b> -40 KC	Nussbaum	2320
11260	<b>20</b> -40 KC	Kirschbaum	2320

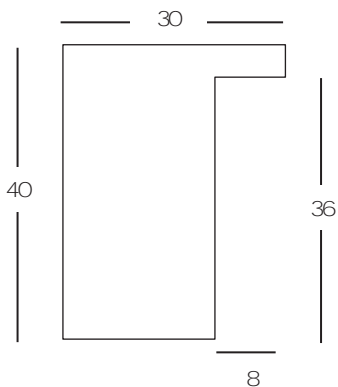

02709	<b>30</b> -40 KC	Wth A	3160
02707	<b>30</b> -40 KC	Fichte	3170
22637	<b>30</b> -40 KC	Linde	3170
02708	<b>30</b> -40 KC	Ahorn	3290
22635	<b>30</b> -40 KC	Eiche	3300
22636	<b>30</b> -40 KC	Nussbaum	3470
22638	<b>30</b> -40 KC	Kirschbaum	3470



Profilschnitt

Art-Nr. Bezeichnung Holzart CHF/m Tarif-Nr.

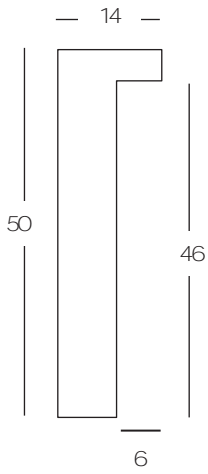

11243	<b>14</b> -50 KC	Fichte	2130
11221	<b>14</b> -50 KC	Linde	2140
11210	<b>14</b> -50 KC	Ahorn	2210
11232	<b>14</b> -50 KC	Eiche	2220
11254	<b>14</b> -50 KC	Nussbaum	2320
30763	<b>14</b> -50 KC	Kirschbaum	2320

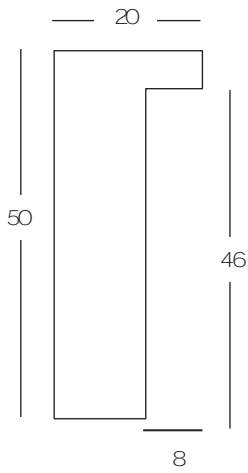

30797	<b>20</b> -50 KC	Fichte	2160
30795	<b>20</b> -50 KC	Linde	2170
30794	<b>20</b> -50 KC	Ahorn	2250
30796	<b>20</b> -50 KC	Eiche	2280
30798	<b>20</b> -50 KC	Nussbaum	2400
30799	<b>20</b> -50 KC	Kirschbaum	2400



Profilschnitt	Art-Nr.	Bezeichnung	Holzart	CHF/m	Tarif-Nr.
---------------	---------	-------------	---------	-------	-----------

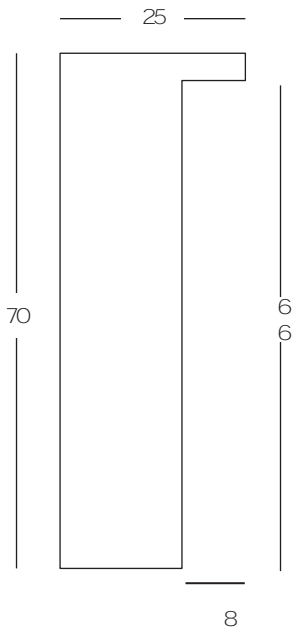

22639	<b>25 -70 KC</b>	Linde		3260
-------	------------------	-------	--	------

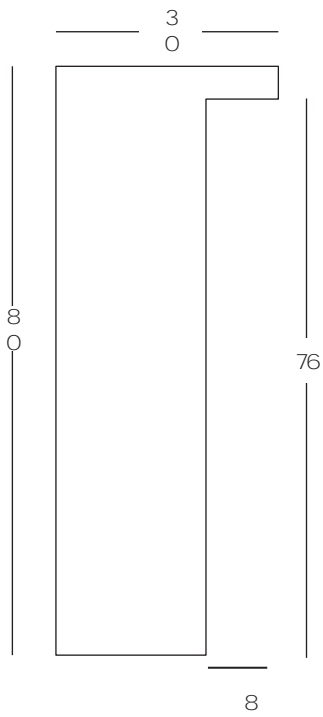

22640	<b>30 -80KC</b>	Linde		3360
-------	-----------------	-------	--	------

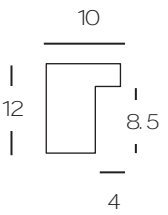
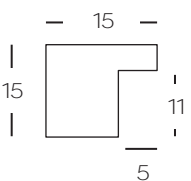
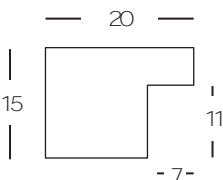
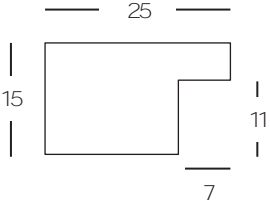
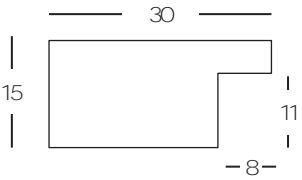
Profilschnitt	Art-Nr.	Bezeichnung	Holzart	CHF/m	Tarif-Nr.
	08001	<b>1</b> -10	Wth A		180
	55201	<b>1</b> -10	Linde		180
	53023	<b>1</b> -10	Eiche		1100
	02678	<b>1</b> -10	Kirschbaum		1130
	02683	<b>1</b> -10	Nussbaum		1130
	10001	<b>1</b> -10	Grundiert		190
	08029	<b>6</b> -15	Wth A		280
	09425	<b>6</b> -15	Fichte		280
	55206	<b>6</b> -15	Linde		2100
	09747	<b>6</b> -15	Ahorn		2110
	53128	<b>6</b> -15	Eiche		2130
	02679	<b>6</b> -15	Kirschbaum		2170
	02684	<b>6</b> -15	Nussbaum		2170
	10025	<b>6</b> -15	Grundiert		2100
	08030	<b>6</b> -20	Wth A		280
	09175	<b>6</b> -20	Fichte		280
	55207	<b>6</b> -20	Linde		2100
	09430	<b>6</b> -20	Ahorn		2110
	53158	<b>6</b> -20	Eiche		2130
	02680	<b>6</b> -20	Kirschbaum		2170
	02685	<b>6</b> -20	Nussbaum		2170
	10008	<b>6</b> -20	Grundiert		2110
	08031	<b>6</b> -25	Wth A		3100
	09435	<b>6</b> -25	Fichte		3100
	55208	<b>6</b> -25	Linde		3100
	09431	<b>6</b> -25	Ahorn		3170
	53157	<b>6</b> -25	Eiche		3170
	10026	<b>6</b> -25	Grundiert		3120
	08032	<b>6</b> -30	Wth A		3100
	09176	<b>6</b> -30	Fichte		3100
	55209	<b>6</b> -30	Linde		3100
	09432	<b>6</b> -30	Ahorn		3170
	53160	<b>6</b> -30	Eiche		3170
	02681	<b>6</b> -30	Kirschbaum		3230
	02686	<b>6</b> -30	Nussbaum		3230
	10027	<b>6</b> -30	Grundiert		3140

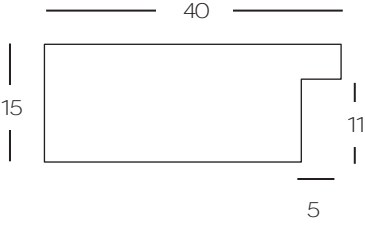
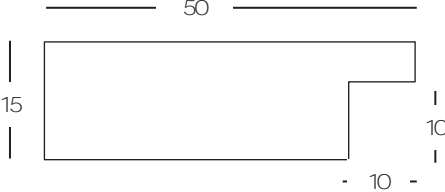
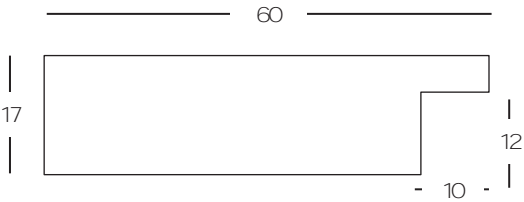
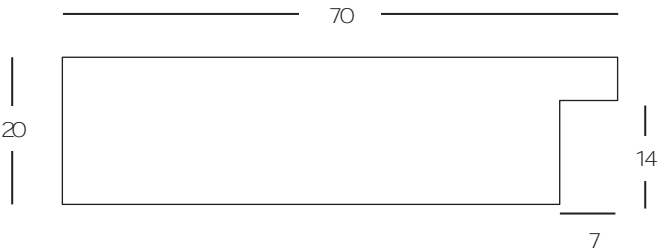
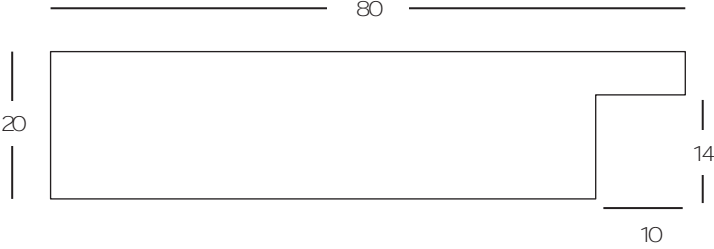
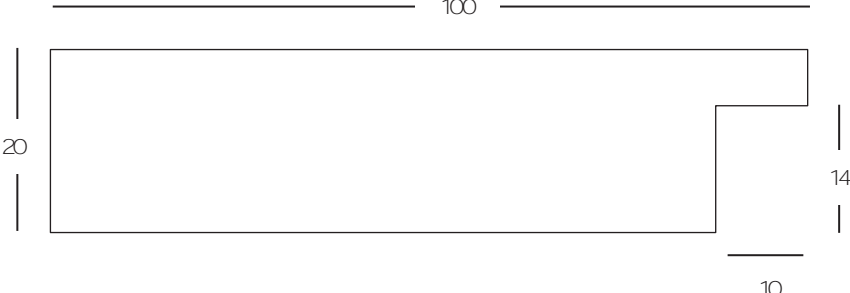
Profilschnitt	Art-Nr.	Bezeichnung	Holzart	CHF/m	Tarif-Nr.
	08033	<b>6 -40</b>	Wth A		4120
	55210	<b>6 -40</b>	Linde		4110
	53159	<b>6 -40</b>	Eiche		4220
	08034	<b>6 -50</b>	Wth A		5130
	55211	<b>6 -50</b>	Linde		5130
	53148	<b>6 -50</b>	Eiche		5220
	06035	<b>6 -60</b>	Wth B		6200
	55212	<b>6 -60</b>	Linde		6210
	08036	<b>6 -70</b>	Wth A		7240
	55213	<b>6 -70</b>	Linde		7260
	06037	<b>6 -80</b>	Wth B		8300
	55214	<b>6 -80</b>	Linde		8320
	06046	<b>6 -100</b>	Wth A		10400
	55215	<b>6 -100</b>	Linde		10420

Profilschnitt	Art-Nr.	Bezeichnung	Holzart	CHF/m	Tarif-Nr.
---------------	---------	-------------	---------	-------	-----------

## Bernerstab

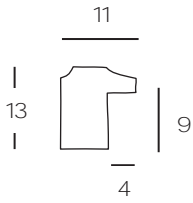

08080	<b>9 -11</b>	Wth A	280
55216	<b>9 -11</b>	Linde	280

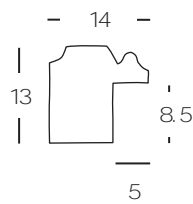

06062	<b>9 -14</b>	Wth B	280
55217	<b>9 -14</b>	Linde	2100
10032	<b>9 -14</b>	Grundiert	2100

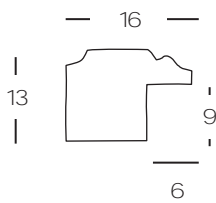

06063	<b>9 -16</b>	Wth B	280
55218	<b>9 -16</b>	Linde	2110

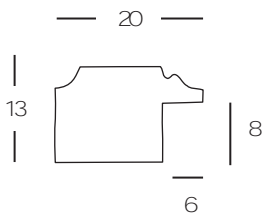

08085	<b>9 -20</b>	Wth A	280
10034	<b>9 -20</b>	Grundiert	2110

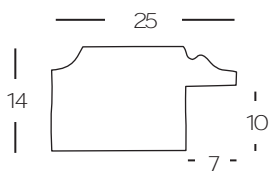

06066	<b>9 -25</b>	Wth B	3100
-------	--------------	-------	------

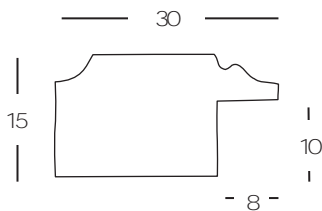

08087	<b>9 -30</b>	Wth A	3110
-------	--------------	-------	------

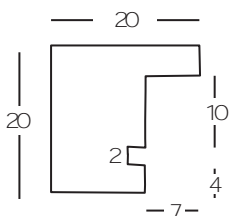

36222	<b>17 -18</b>	Linde	280
-------	---------------	-------	-----

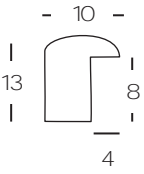
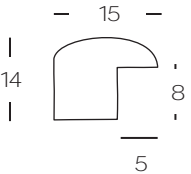
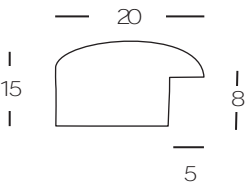
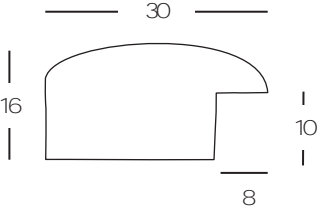
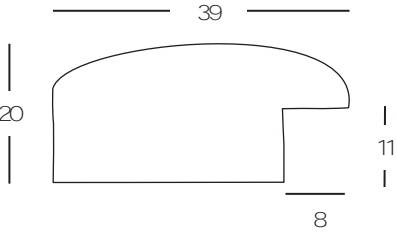
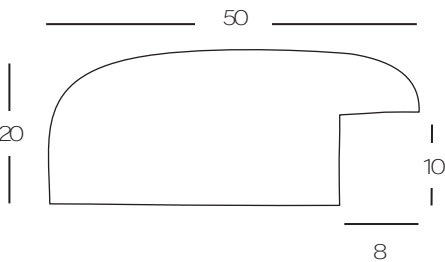
Profilschnitt	Art-Nr.	Bezeichnung	Holzart	CHF/m	Tarif-Nr.
	06211	<b>20 -10 H</b>	Wth B		180
	09646	<b>20 -10 H</b>	Fichte		180
	55243	<b>20 -10 H</b>	Linde		180
	10061	<b>20 -10 H</b>	Grundiert		190
	06212	<b>20 -14 H</b>	Wth B		280
	55260	<b>20 -14 H</b>	Fichte		280
	55244	<b>20 -14 H</b>	Linde		2100
	10062	<b>20 -14 H</b>	Grundiert		2100
	08163	<b>20 -20 H</b>	Wth A		280
	55261	<b>20 -20 H</b>	Fichte		280
	55245	<b>20 -20 H</b>	Linde		2100
	10063	<b>20 -20 H</b>	Grundiert		2110
	06215	<b>20 -30 H</b>	Wth B		3130
	55247	<b>20 -30 H</b>	Linde		3110
	10065	<b>20 -30 H</b>	Grundiert		3140
	08166	<b>20 -40 H</b>	Wth A		4130
	55248	<b>20 -40 H</b>	Linde		4130
	08170	<b>20 -50 H</b>	Wth A		5160
	55249	<b>20 -50 H</b>	Linde		5170

Profilschnitt	Art-Nr.	Bezeichnung	Holzart	CHF/m	Tarif-Nr.
---------------	---------	-------------	---------	-------	-----------

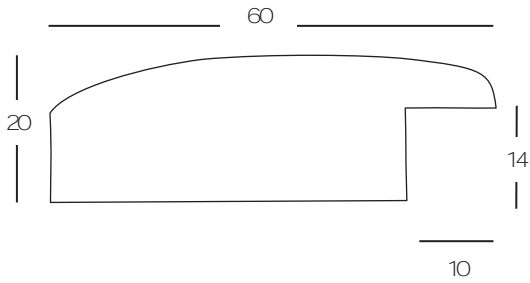

06218	<b>20 -60 H</b>	Wth B	6200
55250	<b>20 -60 H</b>	Linde	6210

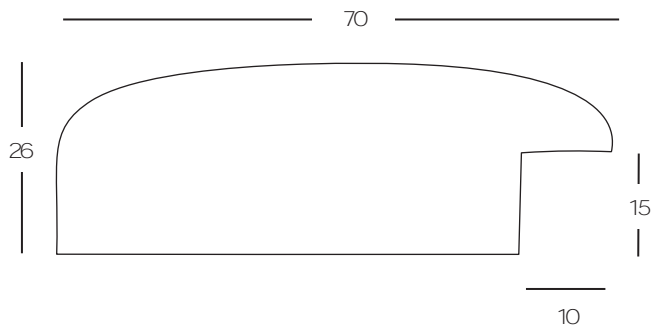

55886	<b>20 -70 H</b>	Wth A	7300
-------	-----------------	-------	------

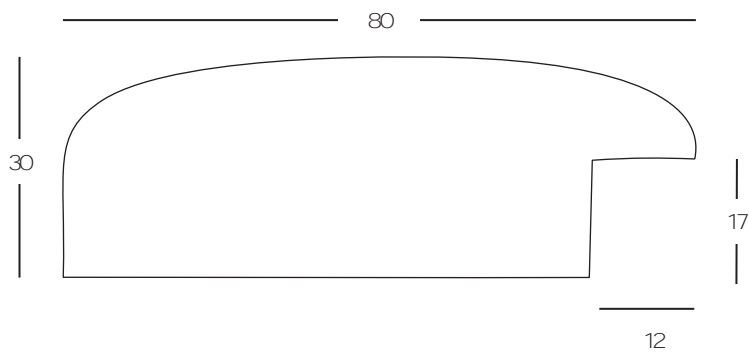

06219	<b>20 -80 H</b>	Wth B	8340
-------	-----------------	-------	------



Profilschnitt	Art-Nr.	Bezeichnung	Holzart	CHF/m	Tarif-Nr.
---------------	---------	-------------	---------	-------	-----------

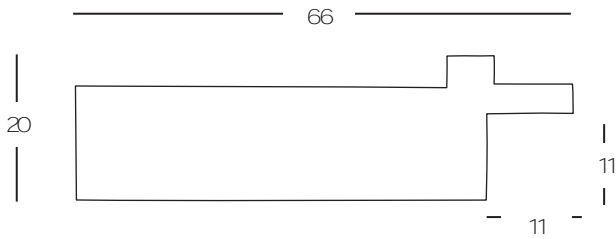

08098	<b>20 -66</b>	Wth A		7240
-------	---------------	-------	--	------

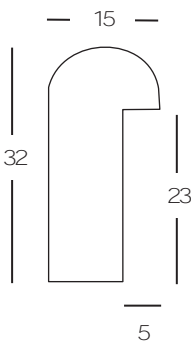

08013	<b>26 -15/32</b>	Wth B		2120
-------	------------------	-------	--	------

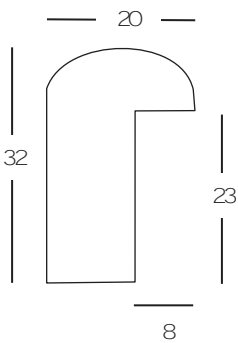

08014	<b>26 -20/32</b>	Wth B		2120
-------	------------------	-------	--	------

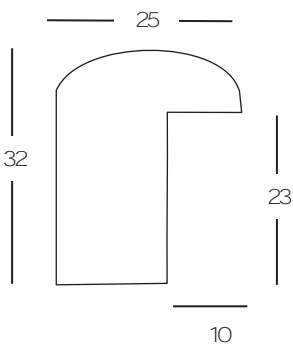

08015	<b>26 -25/32</b>	Wth B		3130
-------	------------------	-------	--	------

Profilschnitt	Art-Nr.	Bezeichnung	Holzart	CHF/m	Tarif-Nr.
---------------	---------	-------------	---------	-------	-----------

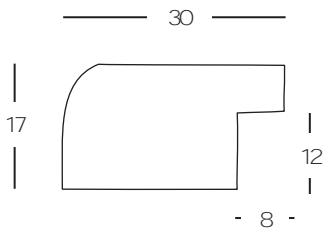

22618	<b>33 -30</b>	Wth A	3120
-------	---------------	-------	------

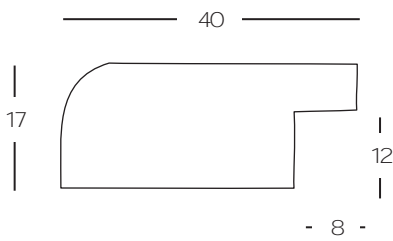

09777	<b>33 -40</b>	Wth B	4130
-------	---------------	-------	------

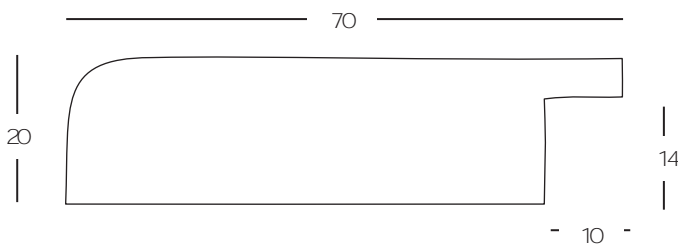

09781	<b>33 -70</b>	Wth B	7240
-------	---------------	-------	------

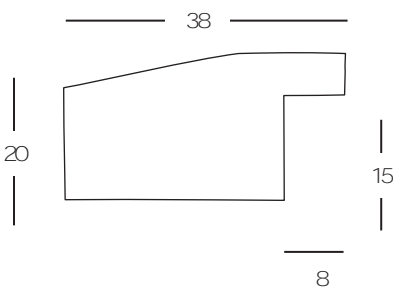

06488	<b>38 -20</b>	Wth B	4130
-------	---------------	-------	------

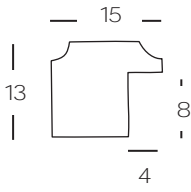
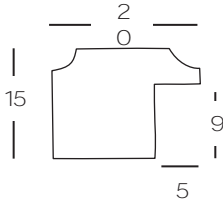
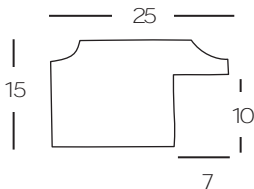
Profilschnitt	Art-Nr.	Bezeichnung	Holzart	CHF/m	Tarif-Nr.
	06511	<b>40 -10</b>	Wth B		180
	55255	<b>40 -10</b>	Linde		180
	10101	<b>40 -10</b>	Grundiert		1100
	22610	<b>40 -15</b>	Wth A		280
	55257	<b>40 -15</b>	Linde		2100
	22609	<b>40 -20</b>	Wth A		280
	55258	<b>40 -20</b>	Linde		2100
	08295	<b>40 -25</b>	Wth A		3100
	55259	<b>40 -25</b>	Linde		3100

Profilschnitt	Art-Nr.	Bezeichnung	Holzart	CHF/m	Tarif-Nr.
---------------	---------	-------------	---------	-------	-----------



30786	<b>53 -60</b>	Wth A	6240
-------	---------------	-------	------

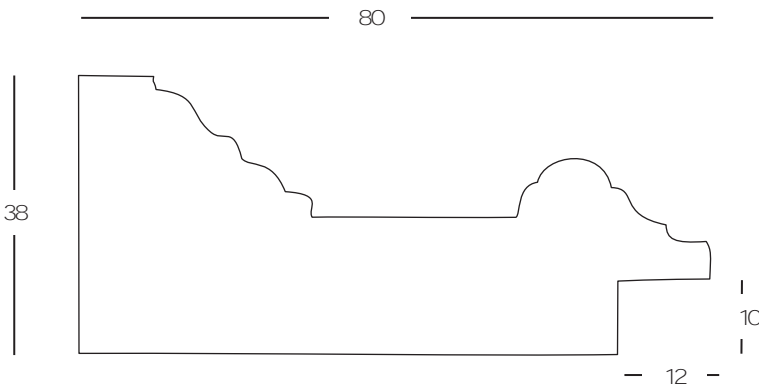

22605	<b>53 -80</b>	Wth A	8390
-------	---------------	-------	------

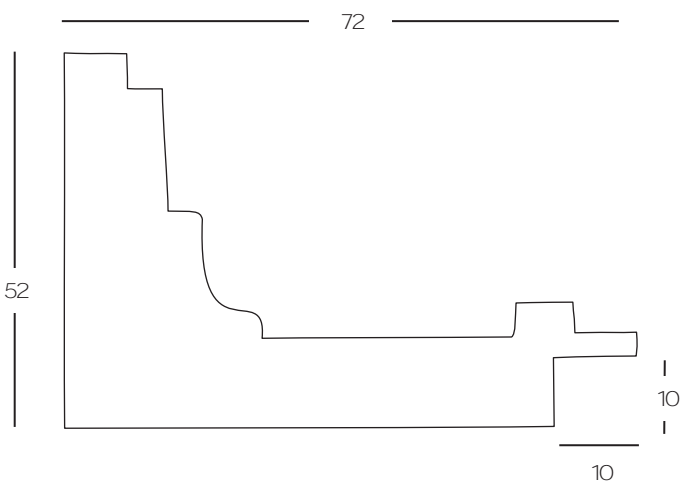

06770	<b>56 -74</b>	Wth B	8390
-------	---------------	-------	------

Profilschnitt	Art-Nr.	Bezeichnung	Holzart	CHF/m	Tarif-Nr.
---------------	---------	-------------	---------	-------	-----------

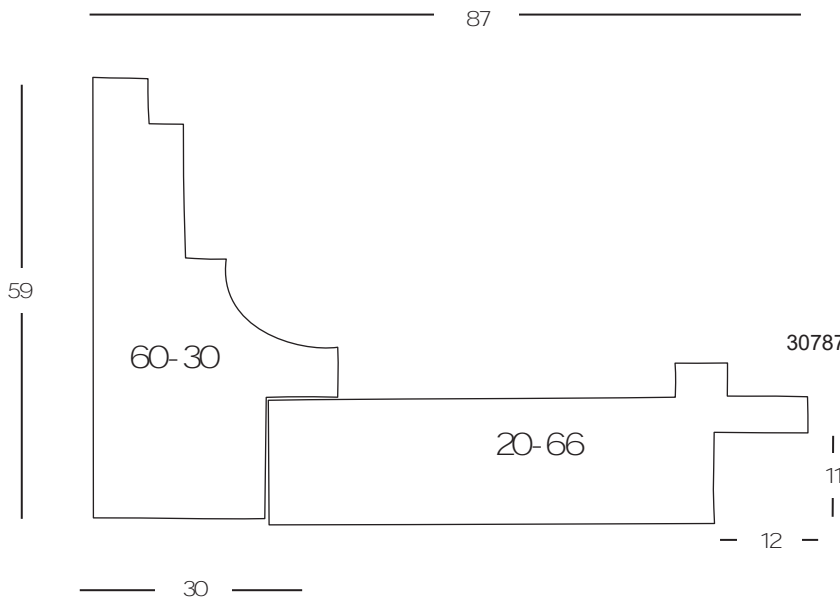

87

59

60-30

20-66

30787

58 -87

Wth A

9450

11

12

30

**Kassette mittel, bestehend aus 2 Profilen**

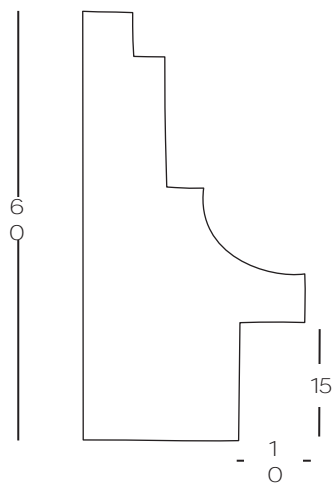

60

06800

60 -30

Wth B

3240

15

10

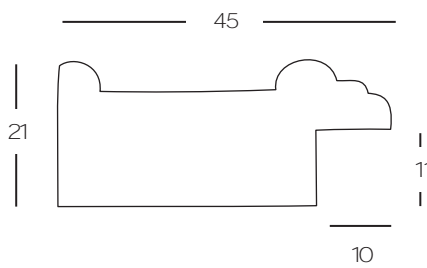

45

21

06880

84 -45

Wth B

5160

11

10

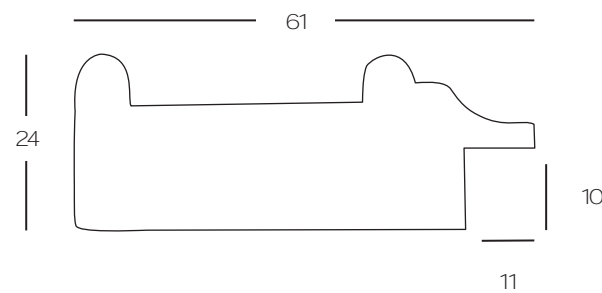

61

24

06881

84 -60

Wth B

6200

10

11

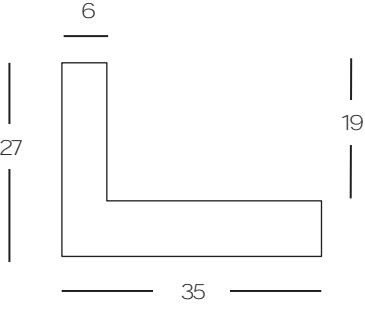
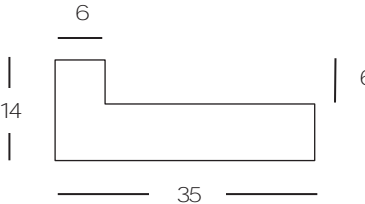
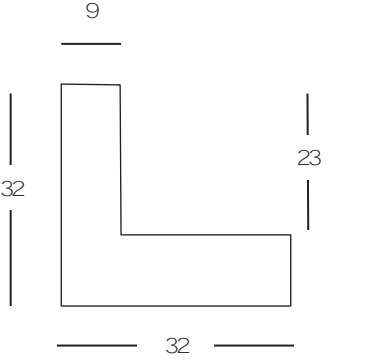
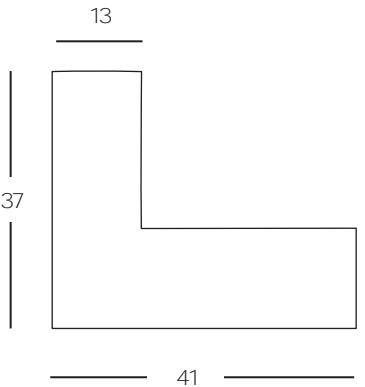
Profilschnitt	Art-Nr.	Bezeichnung	Holzart	CHF/m	Tarif-Nr.
	08454	<b>220</b> -35/19	Linde		4130
		08455	<b>221</b> -35/6	Linde	
		08450	<b>235</b> -32/8	With A	
	09111	<b>235</b> -32/8	Fichte		4130
	55262	<b>235</b> -32/8	Linde		4130
	09420	<b>235</b> -32/8	Ahorn		4210
	09412	<b>235</b> -32/8	Eiche		4220
	09421	<b>235</b> -32/8	Nussbaum		4360
	10279	<b>235</b> -32/8	Grundiert		4170
	08451	<b>238</b> -42/12	With A		5200
	08971	<b>238</b> -42/12	Fichte		5220
	55265	<b>238</b> -42/12	Linde		5210
	22641	<b>238</b> -42/12	Ahorn		5300
	09413	<b>238</b> -42/12	Eiche		5320
	22642	<b>238</b> -42/12	Nussbaum		5550
	10280	<b>238</b> -42/12	Grundiert		5200

Profilschnitt	Art-Nr.	Bezeichnung	Holzart	CHF/m	Tarif-Nr.
---------------	---------	-------------	---------	-------	-----------

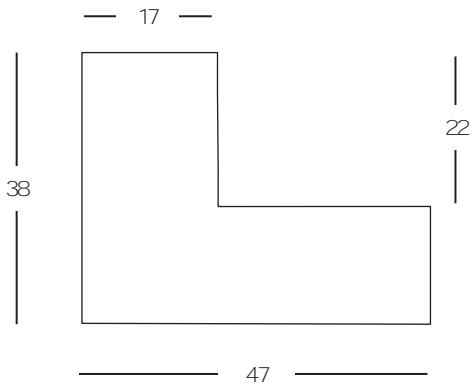

07082	<b>239</b> -47/17	Wth B		5200
-------	-------------------	-------	--	------

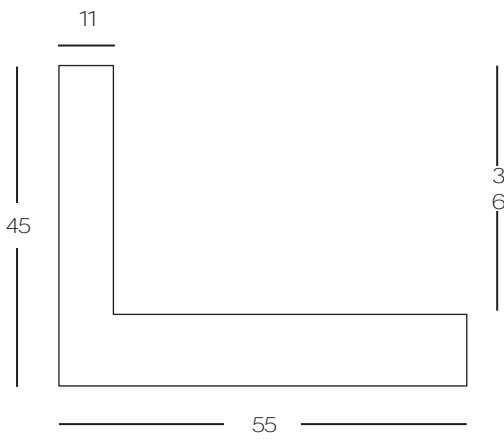

07108	<b>255</b> -45/10	Fichte		6300
07093	<b>255</b> -45/10	Grundiert		6290

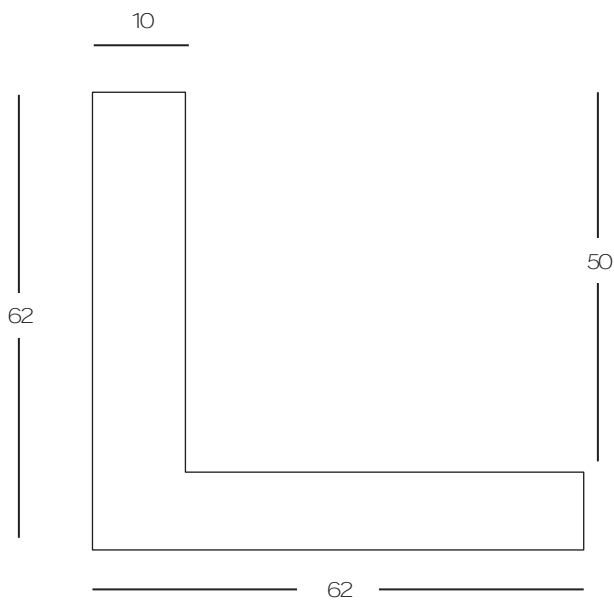

77781	<b>260</b> -62/12	Fichte		7390
-------	-------------------	--------	--	------

Profilschnitt	Art-Nr.	Bezeichnung	Holzart	CHF/m	Tarif-Nr.
---------------	---------	-------------	---------	-------	-----------

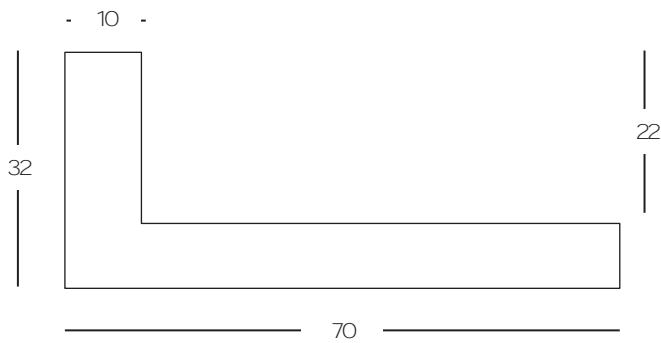

01810	<b>261</b> -70/10	Wth B		7300
-------	-------------------	-------	--	------

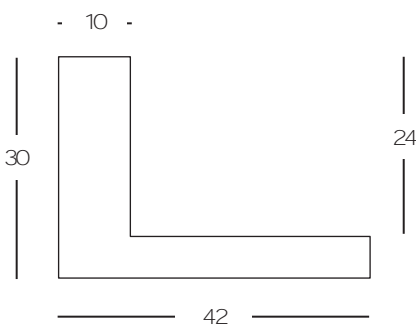

01811	<b>263</b> -42/10	Wth B		5160
-------	-------------------	-------	--	------

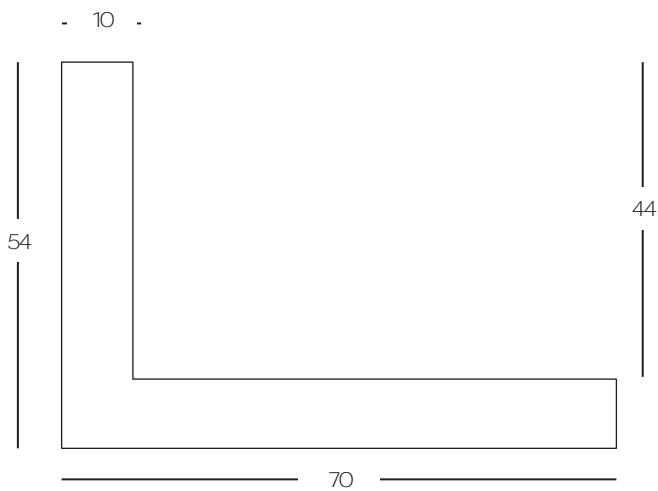

01812	<b>264</b> -70/10	Wth B		7390
-------	-------------------	-------	--	------

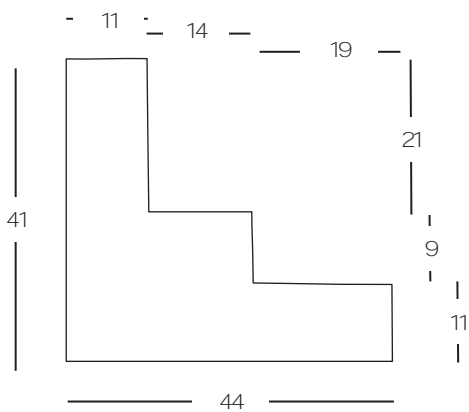

01813	<b>265</b> -44/11	Linde		5210
-------	-------------------	-------	--	------



Profilschnitt	Art-Nr.	Bezeichnung	Holzart	CHF/m	Tarif-Nr.
---------------	---------	-------------	---------	-------	-----------

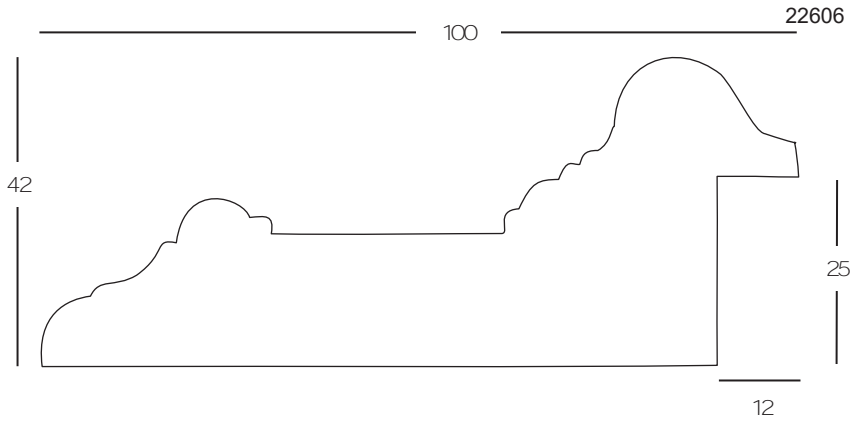

22606	<b>512 -100</b>	Wth A	10500
-------	-----------------	-------	-------

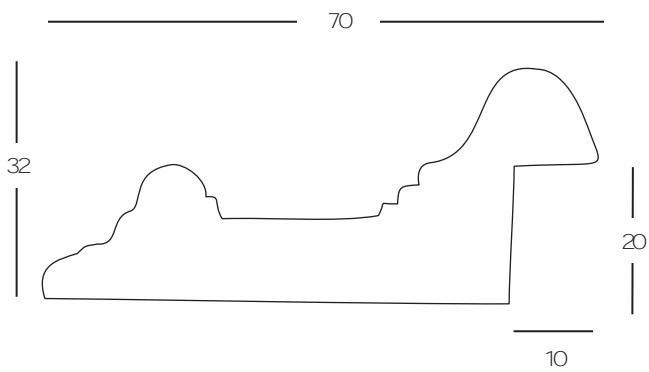

08991	<b>516 -70</b>	Wth A	7300
-------	----------------	-------	------

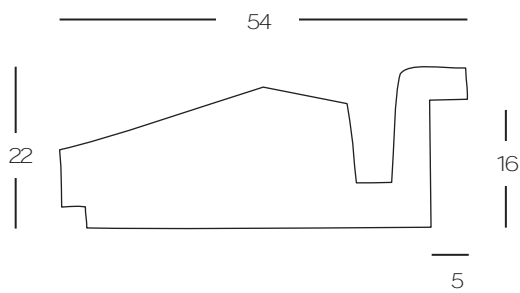

09702	<b>814 -55</b>	Wth B	6200
-------	----------------	-------	------

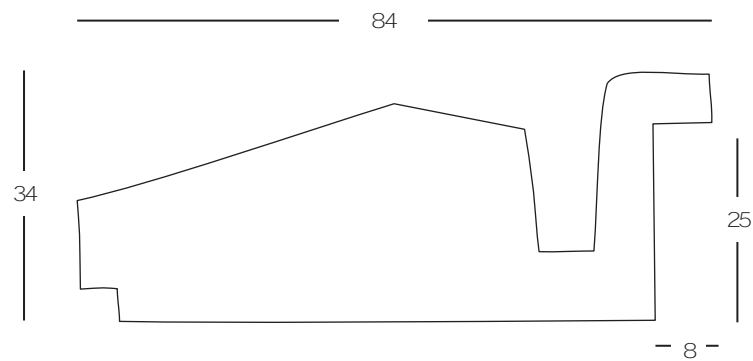

09787	<b>814 -85</b>	Wth B	9390
-------	----------------	-------	------

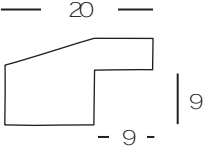
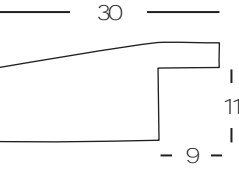
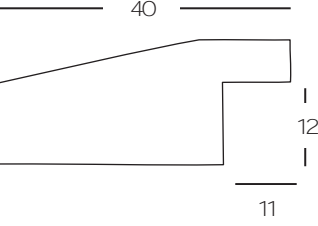
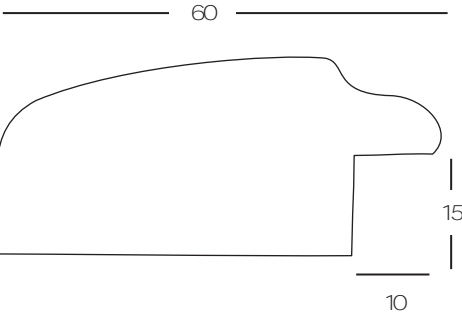
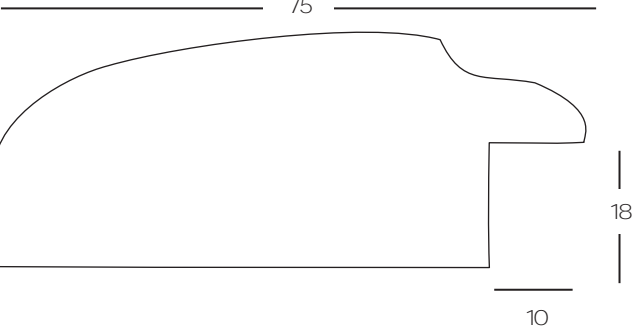
Profilschnitt	Art-Nr.	Bezeichnung	Holzart	CHF/m	Tarif-Nr.
	55269	<b>917</b> -5	Linde		270
	22632	<b>1133</b> -20	Wth A		280
	55887	<b>1133</b> -30	Wth A		3120
	09980	<b>1133</b> -40	Wth B		4130
	07812	<b>3100</b> -60	Wth B		6240
	07813	<b>3100</b> -75	Wth B		8340

Profilschnitt	Art-Nr.	Bezeichnung	Holzart	CHF/m	Tarif-Nr.
---------------	---------	-------------	---------	-------	-----------

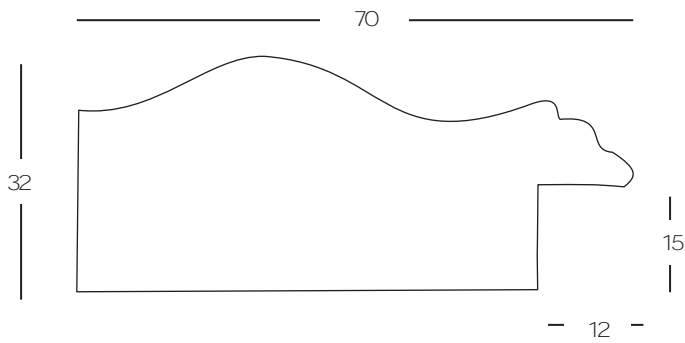

07832	<b>3107 -70</b>	Wth B		7300
-------	-----------------	-------	--	------

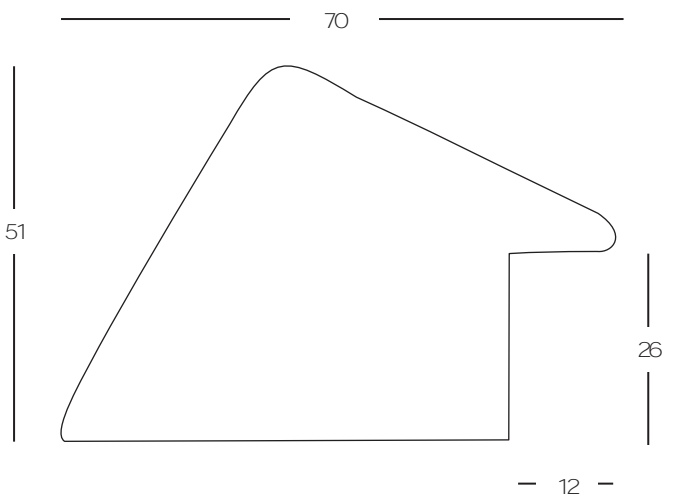

22624	<b>3108 -70</b>	Wth A		7390
-------	-----------------	-------	--	------

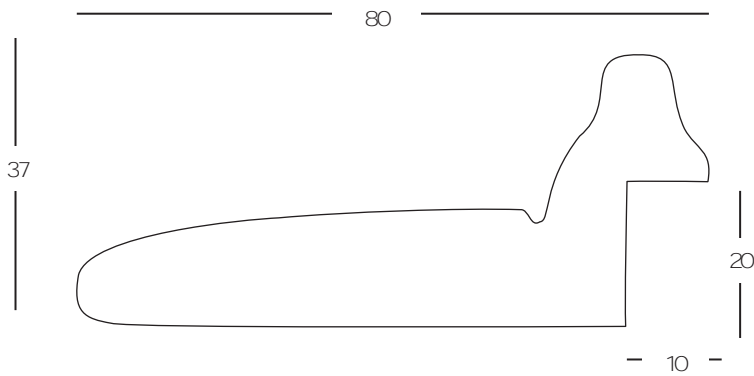

07839	<b>3111 -80</b>	Wth B		8390
-------	-----------------	-------	--	------

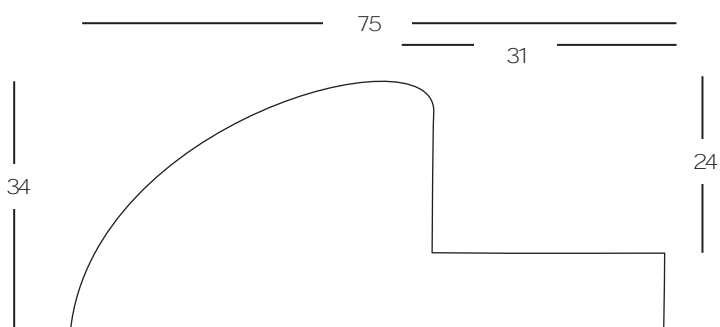

07830	<b>3114 -75</b>	Wth B		8340
-------	-----------------	-------	--	------

Profilschnitt	Art-Nr.	Bezeichnung	Holzart	CHF/m	Tarif-Nr.
---------------	---------	-------------	---------	-------	-----------

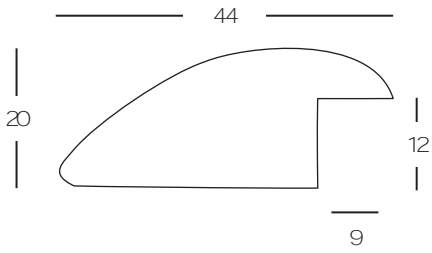

07142	<b>3121 -45</b>	Wth B	5130
-------	-----------------	-------	------

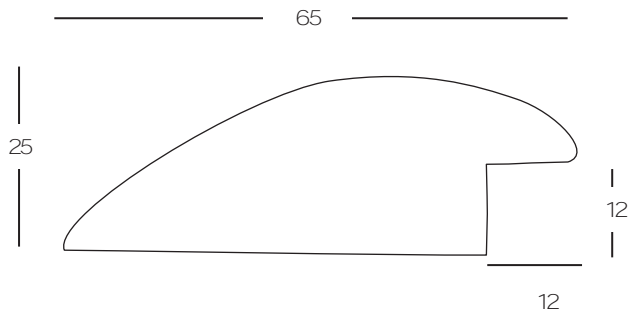

07878	<b>3121 -65</b>	Wth B	7240
-------	-----------------	-------	------

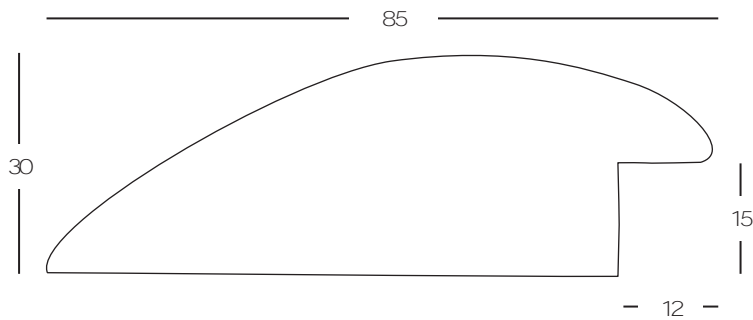

07869	<b>3121 -85</b>	Wth B	9340
-------	-----------------	-------	------

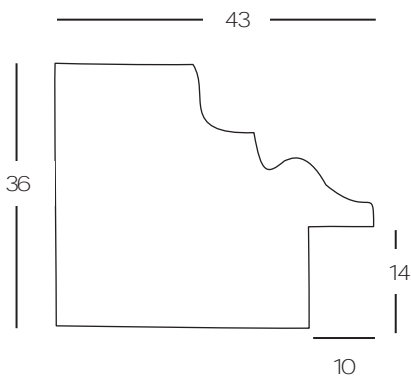

09805	<b>3530 -43</b>	Wth B	5200
-------	-----------------	-------	------

Profilschnitt	Art-Nr.	Bezeichnung	Holzart	CHF/m	Tarif-Nr.
---------------	---------	-------------	---------	-------	-----------

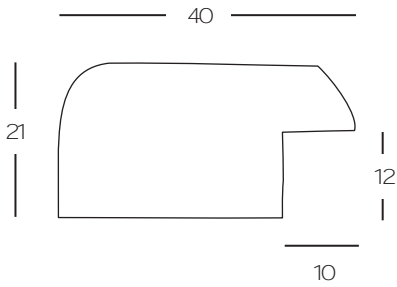

07101	<b>3531</b> -40	Wth B	4130
-------	-----------------	-------	------

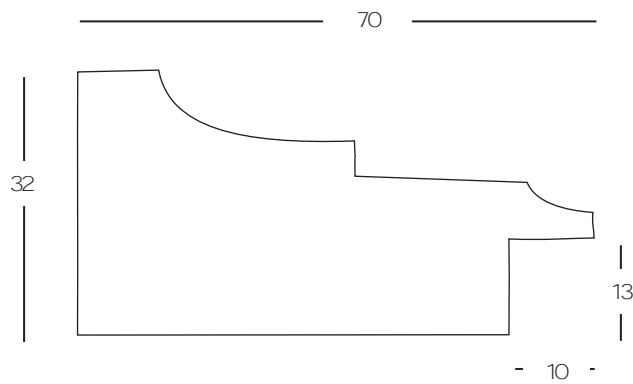

30809	<b>3610</b> -65	Wth A	7300
-------	-----------------	-------	------

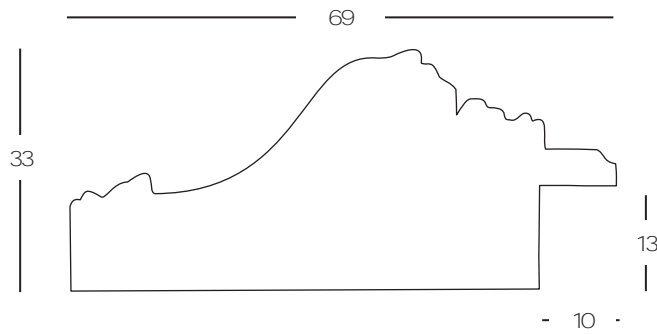

77790	<b>3640</b> -70	Ayous	7240
-------	-----------------	-------	------

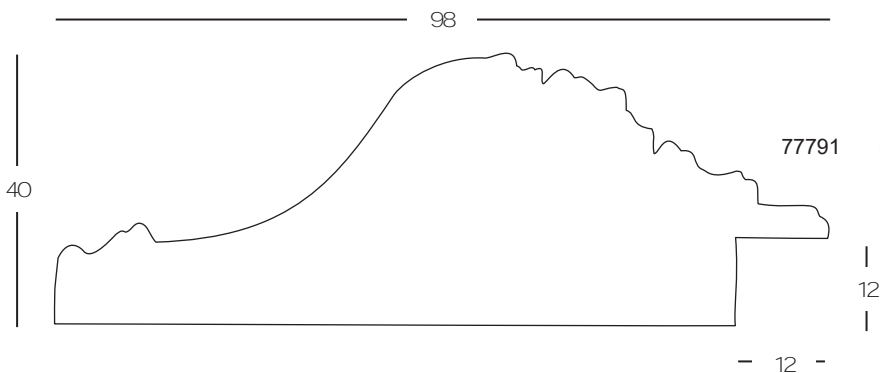

77791	<b>3640</b> -100	Ayous	10420
-------	------------------	-------	-------