



Preise und Zuschläge

Die aufgeführten Preise in der Preisliste verstehen sich per Meter netto.
Zuschneite und Rahmen werden nach dem Tarif berechnet.

Muster

Auf Anfrage stellen wir Ihnen gerne Musterstücke à 25 cm oder Musterwinkel à 17 x 17 cm zur Verfügung.

Mengenrabatte

ab 18 m 5% Rabatt
ab 36 m 8% Rabatt
ab 60 m 10% Rabatt
ab 120 m 12% Rabatt

Diese % gelten pro Nummer und Breite in der gleichen Holzart.

Qualität

Die übliche Stablänge liegt zwischen 2 und 3 m.
Bedenken Sie, dass Naturhölzer lebendige und ungleichmässige Strukturen aufweisen können, welche die Schönheit der Natur ausmachen. Geringe Farb- und Strukturunterschiede, wie z.B. Spiegel bei Eiche oder Riegel bei Ahorn, sind naturgegeben und zu akzeptieren. Für Rahmen wählen wir möglichst homogene Schenkel.

Wth B

Gezinkt, eignet sich zum Grundieren, Vergolden, zum deckend Bearbeiten, so dass die Zinkung unsichtbar ist.
Leistenlänge 3 Meter

Rohleisten Extraanfertigungen / Kehlmesser

Für das Anfertigen von Kehlmessern für Extraprofile verrechnen wir den effektiven Aufwand. Das Material (Stahl) stellen wir kostenlos zur Verfügung. Die Kehlmesser bleiben in unserem Besitze, diese können in keinem Fall vom Kunden angefordert werden.

Mindestbezug für Extraanfertigungen: 60 m.

Grundierte Leisten

Eignen sich zum Vergolden, Lackieren, etc. Leistenlänge 3 m

FSC®-zertifiziert



Das Forest Stewardship Council® ist eine internationale Nicht-Regierungsorganisation, die weltweit eine umweltfreundliche, sozial gerechte und wirtschaftlich tragfähige Bewirtschaftung der Wälder fördert. Für weitere Informationen besuchen Sie www.fsc.org.

Der FSC setzt sich weltweit für die Förderung nachhaltiger Forstwirtschaft ein.

FSC hilft Wälder für zukünftige Generationen zu erhalten.

Der FSC hilft Wälder zu erhalten und schützt die Interessen von Menschen und die Tiere, die in oder von diesen Wäldern leben.

Herkunft Rohhölzer

Ahorn	Schweiz
Ayous	Westafrika
Eiche	USA, EU
Fichte	Schweiz
Weymouthsföhre	Schweiz
Kirschbaum	Schweiz, Frankreich, Kroatien, USA
Linde	Ungarn
Nussbaum	Nordamerika
Tulipwood	Nordamerika



Weymouthsföhre (Wth B)

Leisten sind keilgezinkt eignen sich zum Grundieren und Vergolden

FSC®-zertifiziert



Weymouthsföhre (Wth A)

eignen sich zum Grundieren und Vergolden

FSC®-zertifiziert

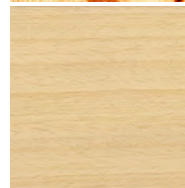

Ayous

Struktur: graugelb, natürlicher Glanz, grosse Poren

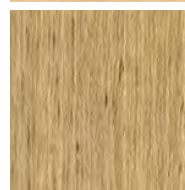

Eiche

Struktur: gefladert, gestreift, mit auffälligen Markstrahlen, glänzend, sehr dekorativ

FSC®-zertifiziert

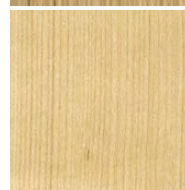

Ahorn

Struktur: schlicht, schwach gefladert/gestreift, gewellt, gemasert, seidig glänzend, sehr dekorativ

FSC®-zertifiziert

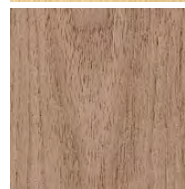

Nussbaum

Struktur: gefladert, glänzend, sehr dekorativ

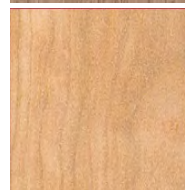

Kirschbaum

Struktur: gefladert, gestreift, geflammt, gemasert, glänzend, sehr dekorativ

FSC®-zertifiziert

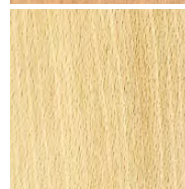

Fichte

Struktur: gefladert, gestreift, schwach glänzend, wenig dekorativ

FSC®-zertifiziert

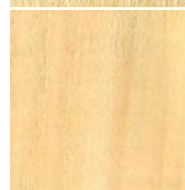

Linde









Struktur: schlicht

FSC®-zertifiziert



Tulipwood

Struktur: kann stark variieren

Profilschnitt	Art-Nr.	Bezeichnung	Holzart	CHF/m	Tarif-Nr.
	09731	1339 -4/6	Wth B	3.70	140
	09732	1339 -4/8	Wth B	3.70	140
	09733	1339 -6/8	Wth B	3.70	140
	09734	1339 -5/10	Wth B	4.30	150
	09735	1339 -8/10	Wth B	4.30	150
	09736	1339 -10/12	Wth B	4.30	150
	09737	1339 -12/15	Wth B	4.50	150
	09739	1339 -10/20	Wth B	4.60	150
	09746	1339 -15/25	Wth B	5.10	160

Distanzleisten



55807	7030	-4/10	Linde	3.60	140
55808	7030	-4/10	Fichte	3.50	140
55809	7030	-4/10	Ahorn	4.60	150
55810	7030	-4/10	Eiche	4.40	150
55811	7030	-4/10	Nussbaum	7.10	180
55812	7030	-4/10	Kirschbaum	6.20	170



55305	7030	-5/5	Linde	3.60	140
09826	7030	-5/5	Fichte	3.50	140
09827	7030	-5/5	Ahorn	4.60	150
09828	7030	-5/5	Eiche	4.40	150
55829	7030	-5/5	Nussbaum	7.10	180
55830	7030	-5/5	Kirschbaum	6.20	170



55306	7030	-5/10	Linde	3.60	140
09829	7030	-5/10	Fichte	3.50	140
09836	7030	-5/10	Ahorn	4.60	150
53066	7030	-5/10	Eiche	4.40	150
55835	7030	-5/10	Nussbaum	7.10	180
5836	7030	-5/10	Kirschbaum	6.20	170

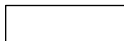

55307	7030	-5/15	Linde	4.10	150
09838	7030	-5/15	Fichte	3.60	140
09840	7030	-5/15	Ahorn	5.10	160
09839	7030	-5/15	Eiche	5.00	150
55841	7030	-5/15	Nussbaum	8.70	190
55842	7030	-5/15	Kirschbaum	7.50	180



55308	7030	-5/20	Linde	4.10	150
09841	7030	-5/20	Fichte	4.10	150
09843	7030	-5/20	Ahorn	5.30	160
09842	7030	-5/20	Eiche	5.40	160
55847	7030	-5/20	Nussbaum	9.80	1100
55848	7030	-5/20	Kirschbaum	8.60	190

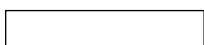

55309	7030	-5/25	Linde	4.60	150
09844	7030	-5/25	Fichte	4.40	150
09846	7030	-5/25	Ahorn	5.90	160
09845	7030	-5/25	Eiche	6.50	170
55853	7030	-5/25	Nussbaum	11.40	1120
55854	7030	-5/25	Kirschbaum	9.80	1100



55310	7030	-5/30	Linde	4.80	150
09847	7030	-5/30	Fichte	4.60	150
09849	7030	-5/30	Ahorn	6.90	170
09848	7030	-5/30	Eiche	6.90	170
55859	7030	-5/30	Nussbaum	12.50	1130
55860	7030	-5/30	Kirschbaum	10.90	1110



55312	7030	-5/40	Linde	6.10	170
09853	7030	-5/40	Fichte	5.70	160
09855	7030	-5/40	Ahorn	8.20	190
09854	7030	-5/40	Eiche	8.10	190
55871	7030	-5/40	Nussbaum	14.90	1150
55872	7030	-5/40	Kirschbaum	12.90	1130



22643	7030	-7/25	Linde	5.30	160
22644	7030	-7/25	Fichte	5.10	160
22645	7030	-7/25	Ahorn	7.20	180
22646	7030	-7/25	Eiche	7.70	180
22647	7030	-7/25	Nussbaum	12.90	1130
22648	7030	-7/25	Kirschbaum	11.40	1120



22649	7030	-7/35	Linde	6.40	170
22650	7030	-7/35	Fichte	5.80	160
22651	7030	-7/35	Ahorn	9.00	190
22652	7030	-7/35	Eiche	9.10	1100
22653	7030	-7/35	Nussbaum	15.90	1160
22654	7030	-7/35	Kirschbaum	13.80	1140



22655	7030	-7/50	Linde	7.40	180
22656	7030	-7/50	Fichte	7.00	170



22657	7030	-7/60	Linde	11.00	1110
-------	-------------	-------	-------	--------------	------

Keilrahmenprofil

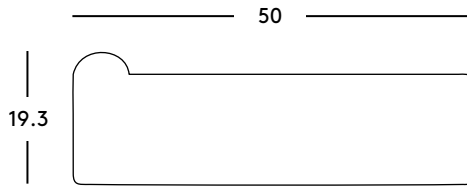

07920 **1340** -50/18 Fichte **5.70**

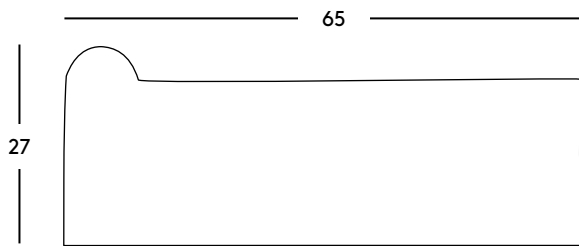

53170 **1340** -65/27 Fichte **10.50**

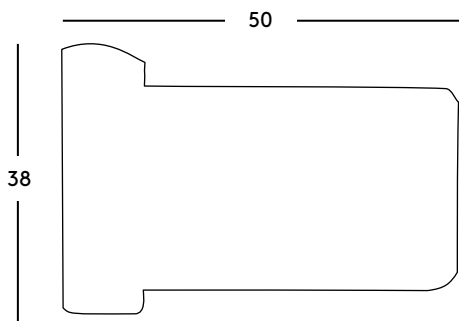

07921 **1340** -50/38 Fichte **10.30**

Querstreben für Keilrahmen

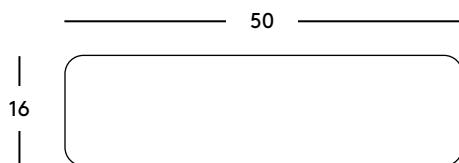

53171 **1330** -50/15 Fichte **5.70**

Zugeschnittene Keilrahmen finden Sie im Register "Einrahmungstarife".

Verstärkungsleisten / Aufhängeleisten

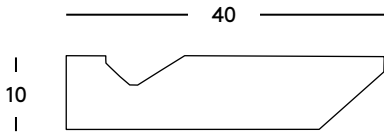

09116 **40** -10AL Tulipwood **7.80** 480

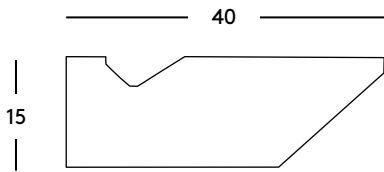

09117 **40** -15AL Tulipwood **10.70** 4110

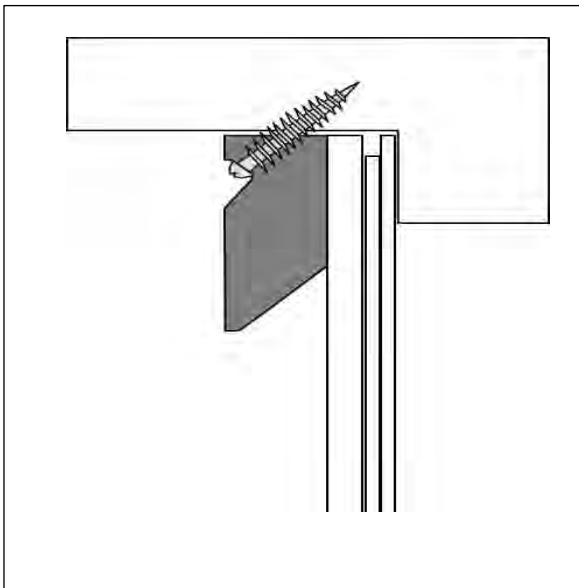

Kastenprofile

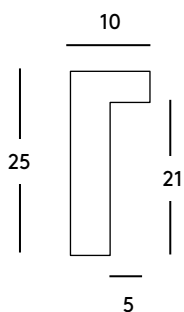

11263	10 -25 KC	Wth A	10.20	1100
11235	10 -25 KC	Fichte	10.20	1100
30737	10 -25 KC	Linde	10.80	1110
30731	10 -25 KC	Ahorn	13.60	1140
30743	10 -25 KC	Eiche	14.40	1150
11246	10 -25 KC	Nussbaum	19.00	1190
30753	10 -25 KC	Kirschbaum	19.00	1190

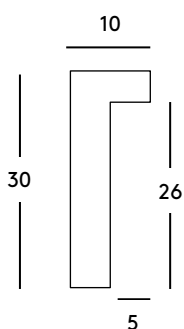

08850	10 -30 KC	Wth A	10.90	1110
11236	10 -30 KC	Fichte	10.90	1110
30738	10 -30 KC	Linde	11.40	1120
11204	10 -30 KC	Ahorn	16.40	1170
30744	10 -30 KC	Eiche	17.60	1180
30754	10 -30 KC	Kirschbaum	25.40	1250
11247	10 -30 KC	Nussbaum	25.40	1250

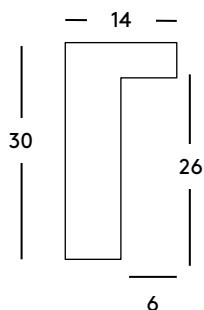

08858	14 -30 KC	Wth A	10.90	2110
11238	14 -30 KC	Fichte	11.50	2120
30739	14 -30 KC	Linde	12.10	2130
11205	14 -30 KC	Ahorn	18.50	2190
30745	14 -30 KC	Eiche	19.20	2200
11249	14 -30 KC	Nussbaum	30.10	2310
30761	14 -30 KC	Kirschbaum	30.00	2300

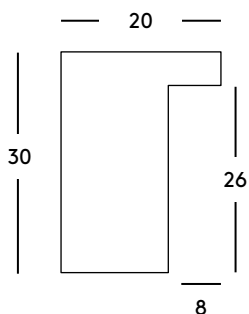

08995	20 -30 KC	Wth A	12.80	2130
30779	20 -30 KC	Fichte	12.80	2130
30777	20 -30 KC	Linde	13.60	2140
30776	20 -30 KC	Ahorn	19.90	2200
30778	20 -30 KC	Eiche	24.50	2250
30780	20 -30 KC	Nussbaum	33.70	2340
30781	20 -30 KC	Kirschbaum	33.40	2340

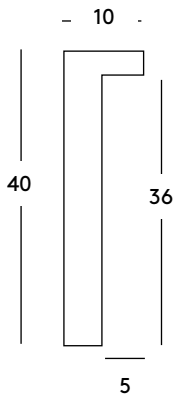

11239	10 -40 KC	Fichte	12.20	1120
30740	10 -40 KC	Linde	12.80	1130
30734	10 -40 KC	Ahorn	19.10	1200
30746	10 -40 KC	Eiche	19.90	1200
11250	10 -40 KC	Nussbaum	27.70	1280
30755	10 -40 KC	Kirschbaum	27.70	1270

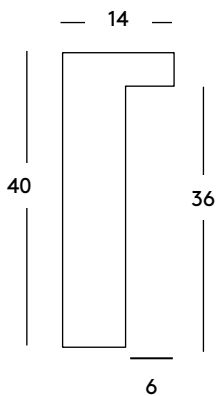

11241	14 -40 KC	Fichte	12.80	2130
30742	14 -40 KC	Linde	12.80	2130
30736	14 -40 KC	Ahorn	21.50	2220
30748	14 -40 KC	Eiche	22.50	2230
11252	14 -40 KC	Nussbaum	31.10	2320
30762	14 -40 KC	Kirschbaum	31.10	2320

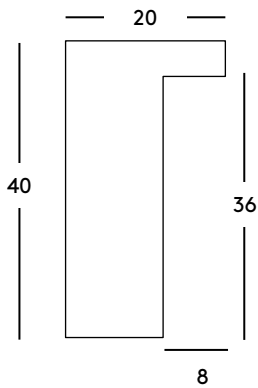

08861	20 -40 KC	Wth A	14.50	2150
11258	20 -40 KC	Fichte	14.50	2150
11256	20 -40 KC	Linde	15.20	2160
11255	20 -40 KC	Ahorn	23.90	2240
11257	20 -40 KC	Eiche	24.90	2250
11259	20 -40 KC	Nussbaum	36.70	2370
11260	20 -40 KC	Kirschbaum	36.00	2360

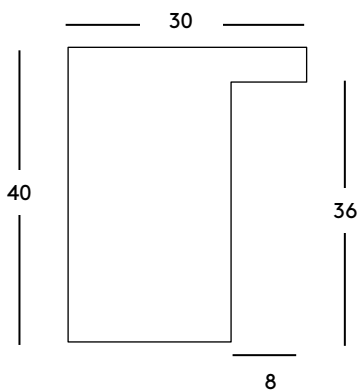

02709	30 -40 KC	Wth A	17.90	3180
02707	30 -40 KC	Fichte	19.30	3200
22637	30 -40 KC	Linde	19.30	3200
02708	30 -40 KC	Ahorn	32.50	3330
22635	30 -40 KC	Eiche	35.10	3360
22636	30 -40 KC	Nussbaum	53.60	3540
22638	30 -40 KC	Kirschbaum	53.20	3540

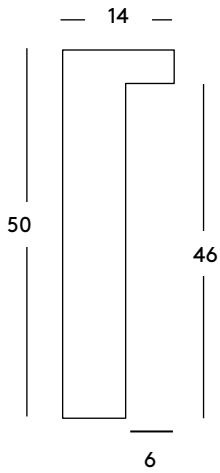

11243	14 -50 KC	Fichte	14.50	2150
11221	14 -50 KC	Linde	15.20	2160
11210	14 -50 KC	Ahorn	23.90	2240
11232	14 -50 KC	Eiche	24.90	2250
11254	14 -50 KC	Nussbaum	36.50	2370
30763	14 -50 KC	Kirschbaum	35.80	2360

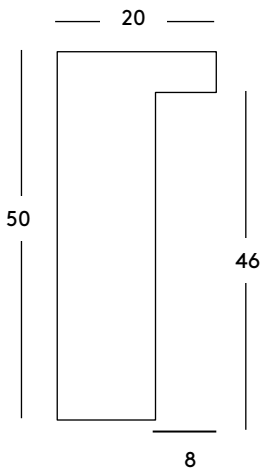

30797	20 -50 KC	Fichte	17.90	2180
30795	20 -50 KC	Linde	18.90	2190
30794	20 -50 KC	Ahorn	27.80	2280
30796	20 -50 KC	Eiche	32.80	2330
30798	20 -50 KC	Nussbaum	45.30	2460
30799	20 -50 KC	Kirschbaum	45.10	2460

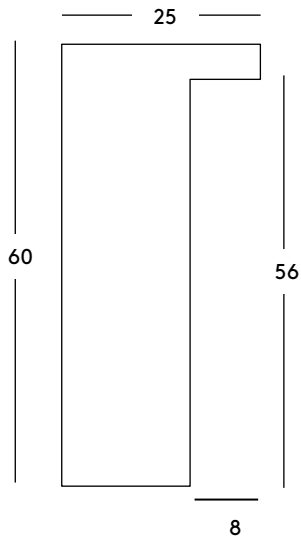

08114	25 -60 KC	Fichte	24.30	3240
08113	25 -60 KC	Linde	24.70	3250
08115	25 -60 KC	Eichen	37.20	3380

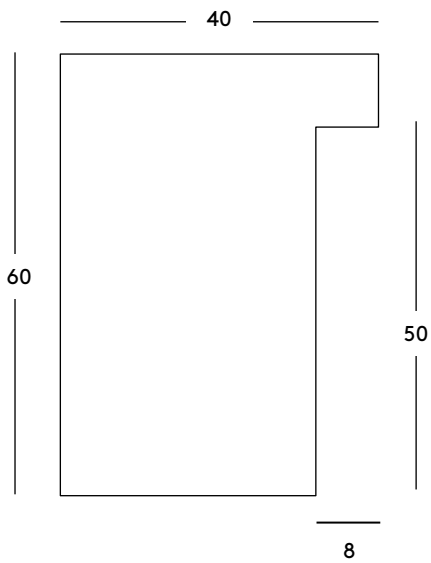

09141	40 -60 K	Nussbaum	97.40	4980
09145	40 -60 K	Kirschbaum	97.40	4980

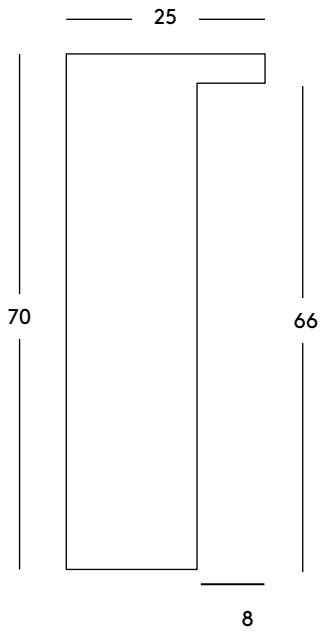

22639 **25 -70 KC** Linde **29.90** 3300

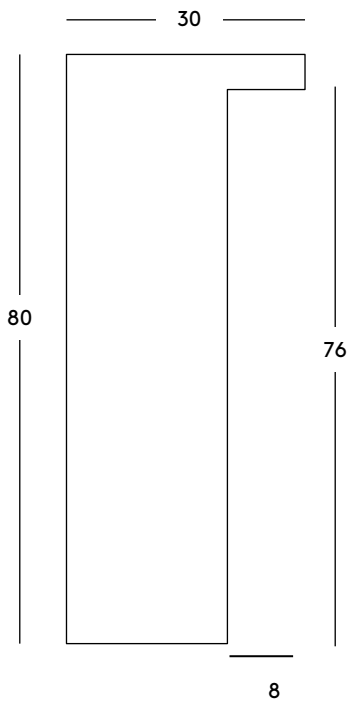

22640 **30 -80KC** Linde **41.40** 3420

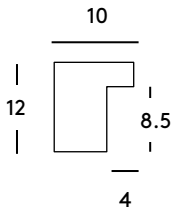

08001	1 -10	Wth A	8.60	190
55201	1 -10	Linde	9.10	190
53023	1 -10	Eiche	11.60	1120
02678	1 -10	Kirschbaum	14.80	1150
02683	1 -10	Nussbaum	14.80	1150
10001	1 -10	Grundiert	10.10	1110

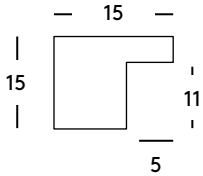

08029	6 -15	Wth A	9.00	290
09425	6 -15	Fichte	9.00	290
55206	6 -15	Linde	10.80	2110
09747	6 -15	Ahorn	12.40	2130
53128	6 -15	Eiche	14.40	2150
02679	6 -15	Kirschbaum	19.10	2200
02684	6 -15	Nussbaum	19.10	2200
10025	6 -15	Grundiert	11.30	2120

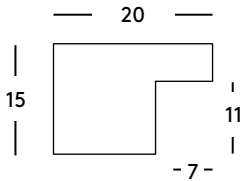

08030	6 -20	Wth A	9.00	290
09175	6 -20	Fichte	9.00	290
55207	6 -20	Linde	10.80	2110
09430	6 -20	Ahorn	12.40	2130
53158	6 -20	Eiche	14.40	2150
02680	6 -20	Kirschbaum	19.10	2200
02685	6 -20	Nussbaum	19.10	2200
10008	6 -20	Grundiert	12.20	2130

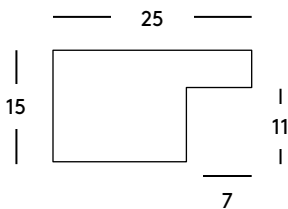

08031	6 -25	Wth A	10.90	3110
09435	6 -25	Fichte	10.90	3110
55208	6 -25	Linde	11.40	3120
09431	6 -25	Ahorn	18.50	3190
53157	6 -25	Eiche	19.10	3200
10026	6 -25	Grundiert	12.70	3130

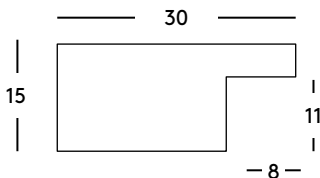

08032	6 -30	Wth A	10.90	3110
09176	6 -30	Fichte	10.90	3110
55209	6 -30	Linde	11.40	3120
09432	6 -30	Ahorn	18.50	3190
53160	6 -30	Eiche	19.10	3200
02681	6 -30	Kirschbaum	25.40	3250
02686	6 -30	Nussbaum	25.40	3250
10027	6 -30	Grundiert	15.60	3160

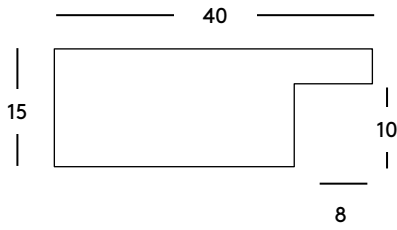

08033	6 -40	Wth A	13.00	4130
55210	6 -40	Linde	12.20	4120
53159	6 -40	Eiche	24.50	4250

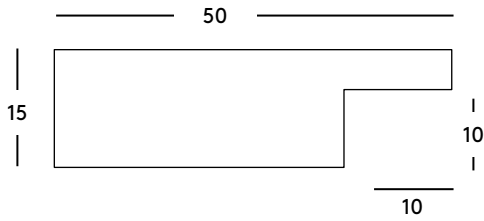

08034	6 -50	Wth A	14.50	5150
55211	6 -50	Linde	14.50	5150
53148	6 -50	Eiche	24.90	5250

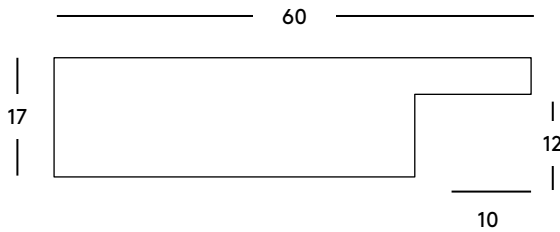

08035	6 -60	Wth A	22.30	6230
55212	6 -60	Linde	23.50	6230

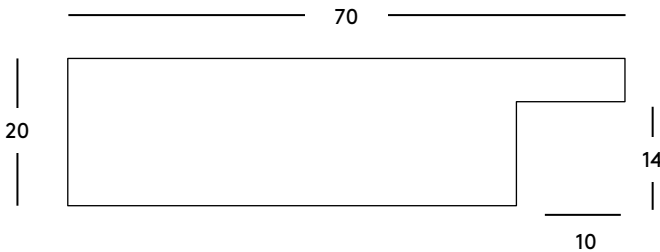

08036	6 -70	Wth A	26.60	7260
55213	6 -70	Linde	28.90	7290

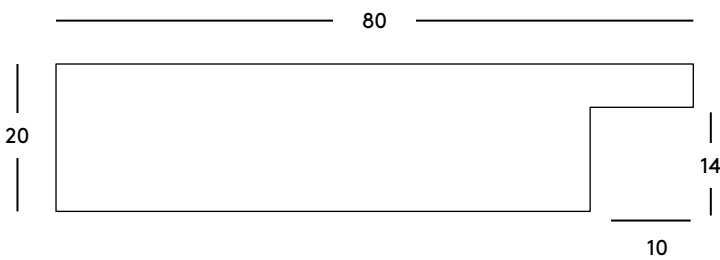

06037	6 -80	Wth B	33.60	8340
55214	6 -80	Linde	35.90	8350

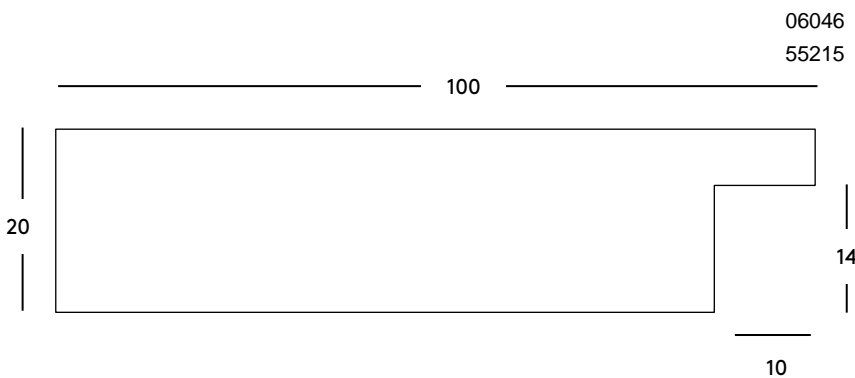

06046	6 -100	Wth A	44.40	10450
55215	6 -100	Linde	47.70	10480

Bernerstab

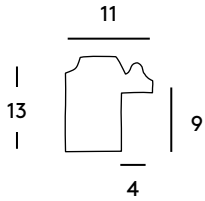

08080	9 -11	Wth A	8.60	290
55216	9 -11	Linde	9.10	2100

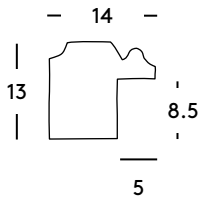

06062	9 -14	Wth B	8.40	290
55217	9 -14	Linde	10.80	2110
10032	9 -14	Grundiert	11.20	2120

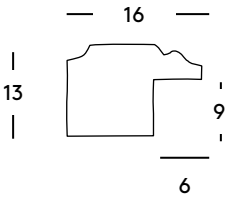

08083	9 -16	Wth A	9.00	290
55218	9 -16	Linde	11.10	2120

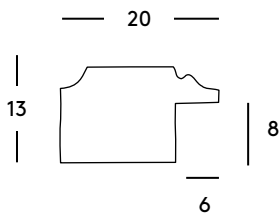

08085	9 -20	Wth A	9.00	290
10034	9 -20	Grundiert	12.40	2130

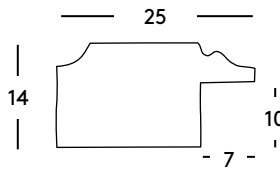

08086	9 -25	Wth A	10.40	3110
-------	-------	-------	--------------	------

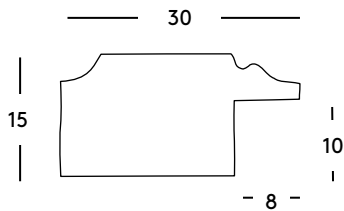

08087	9 -30	Wth A	12.10	3120
-------	-------	-------	--------------	------

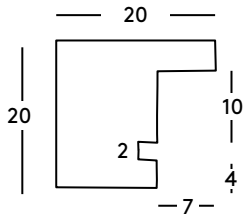

36222	17 -18	Linde	10.80	2110
-------	--------	-------	--------------	------

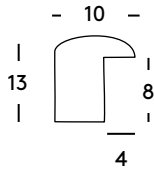

06211	20 -10 H	Wth B	8.10	190
09646	20 -10 H	Fichte	8.60	190
55243	20 -10 H	Linde	9.10	190
10061	20 -10 H	Grundiert	10.00	1100

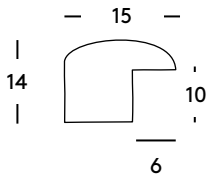

08162	20 -14 H	Wth A	9.00	290
55260	20 -14 H	Fichte	9.00	290
55244	20 -14 H	Linde	10.80	2110
10062	20 -14 H	Grundiert	10.70	2110

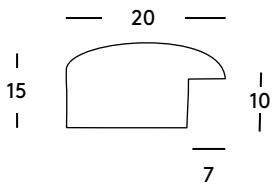

08163	20 -20 H	Wth A	9.00	290
55261	20 -20 H	Fichte	9.00	290
55245	20 -20 H	Linde	10.80	2110
10063	20 -20 H	Grundiert	12.20	2130

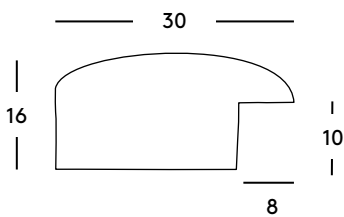

08165	20 -30 H	Wth A	12.20	3130
55247	20 -30 H	Linde	12.20	3120
10065	20 -30 H	Grundiert	15.20	3160

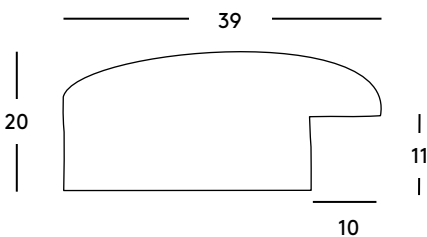

08166	20 -40 H	Wth A	14.50	4150
55248	20 -40 H	Linde	14.50	4150

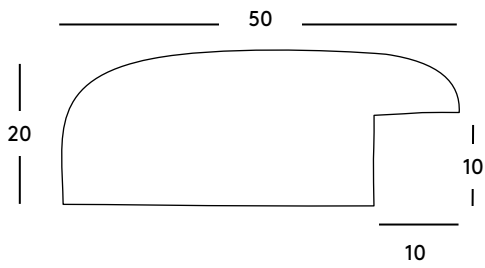

08170	20 -50 H	Wth A	17.90	5180
55249	20 -50 H	Linde	18.90	5190

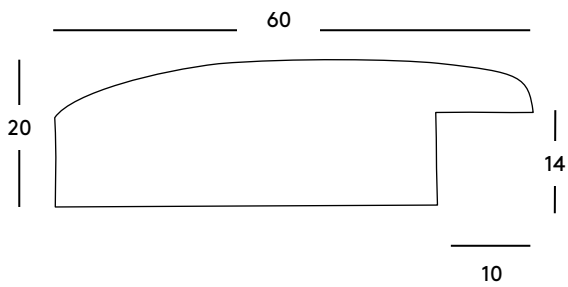

08171	20 -60 H	Wth A	22.30	6230
55250	20 -60 H	Linde	23.50	6240

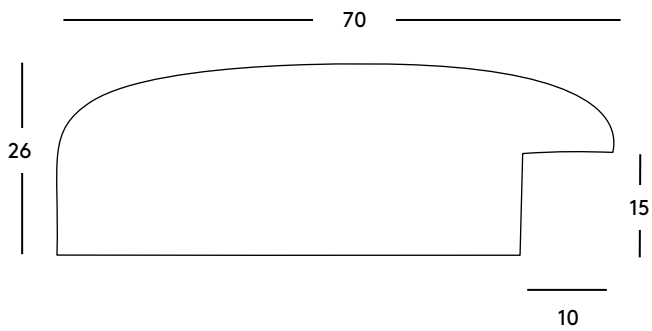

55886	20 -70 H	Wth A	34.50	7350
-------	-----------------	-------	--------------	------

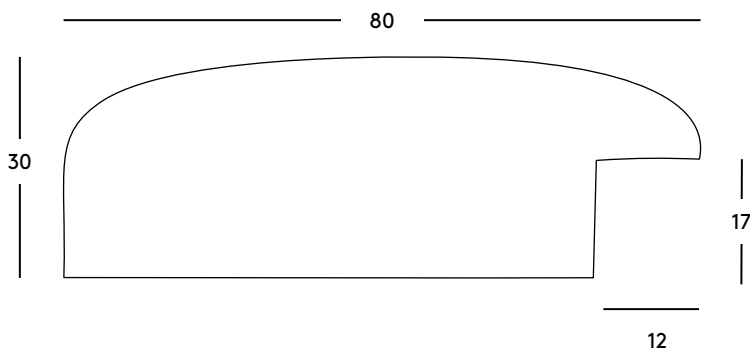

06219	20 -80 H	Wth B	37.90	8380
-------	-----------------	-------	--------------	------

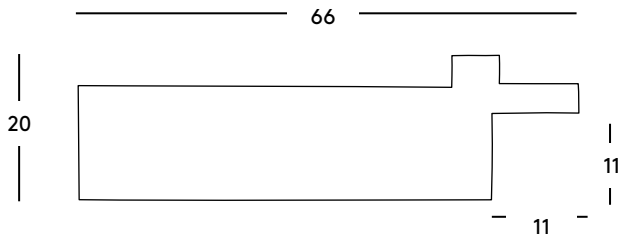

08098 **20** -66 Wth A **26.60** 7260

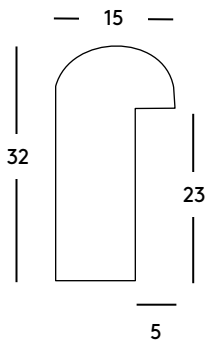

22658 **26** -15/32 Wth A **13.00** 2130

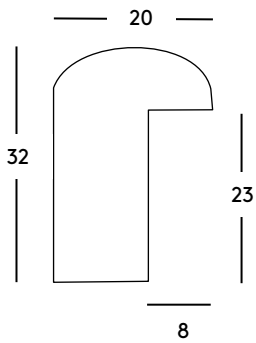

08014 **26** -20/32 Wth B **13.30** 2140

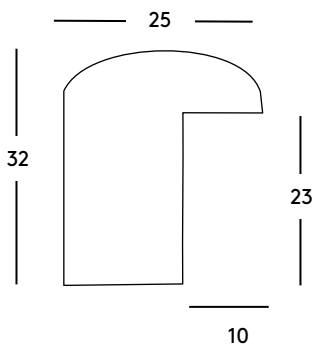

08015 **26** -25/32 Wth B **14.20** 3150

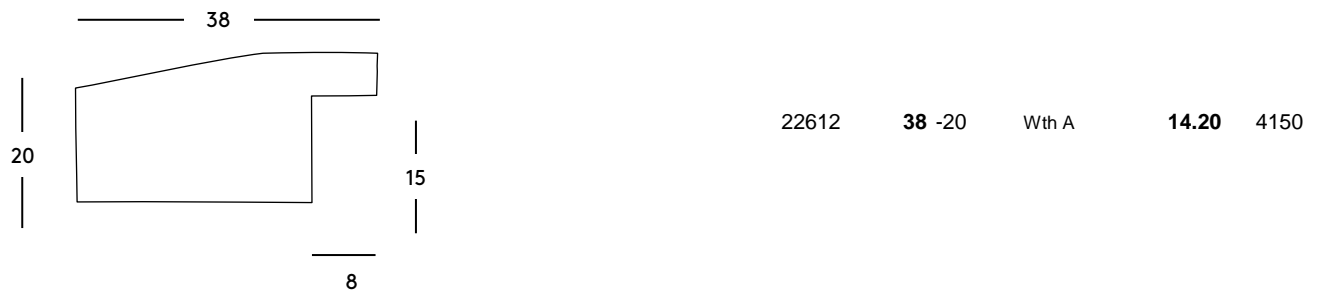
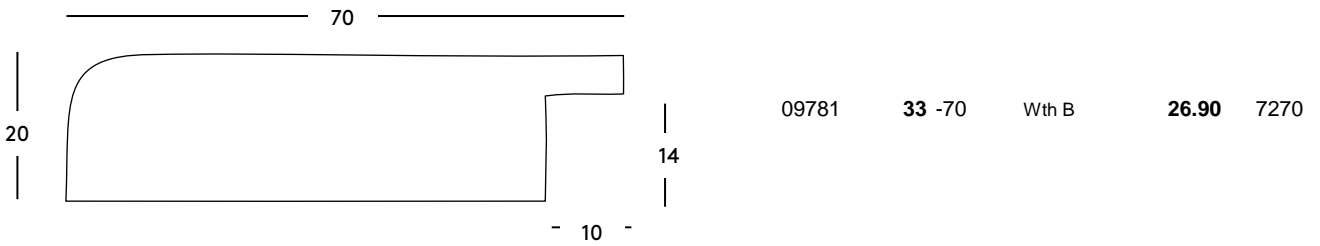

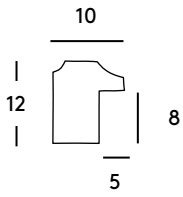

22611	40 -10	Wth A	8.50	190
55255	40 -10	Linde	9.10	1100
10101	40 -10	Grundiert	10.70	1110

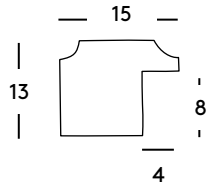

22610	40 -15	Wth A	9.00	290
55257	40 -15	Linde	10.80	2110

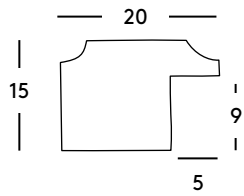

22609	40 -20	Wth A	9.00	290
55258	40 -20	Linde	10.80	2110

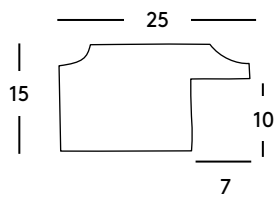

08295	40 -25	Wth A	10.90	3110
55259	40 -25	Linde	11.40	3120

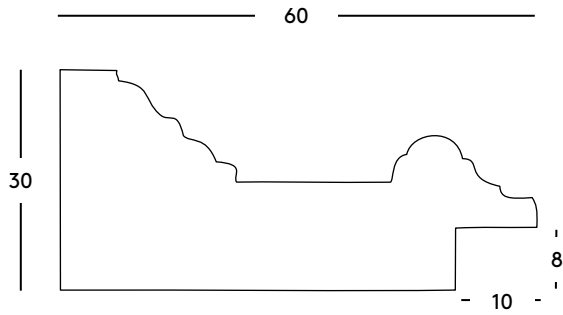

30786 **53 -60** With A **26.60** 6270

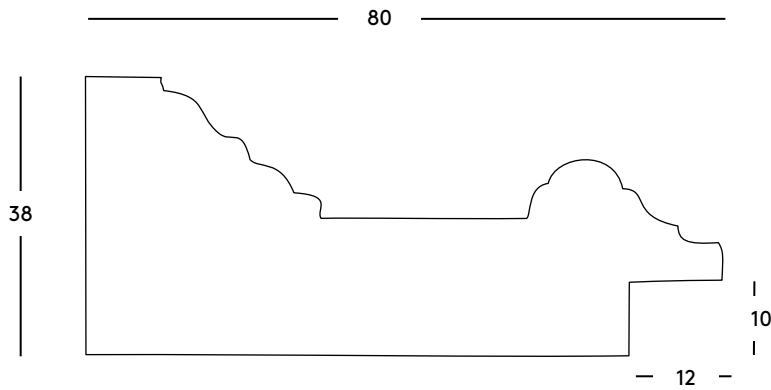

22605 **53 -80** With A **44.40** 8450

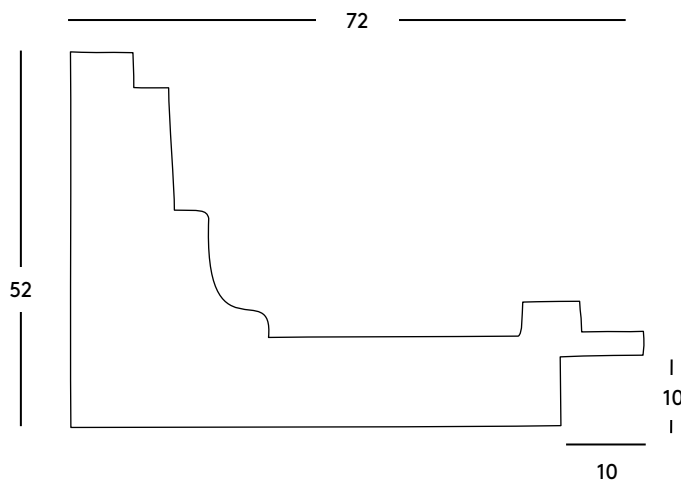

22603 **56 -74** With A **44.40** 8450

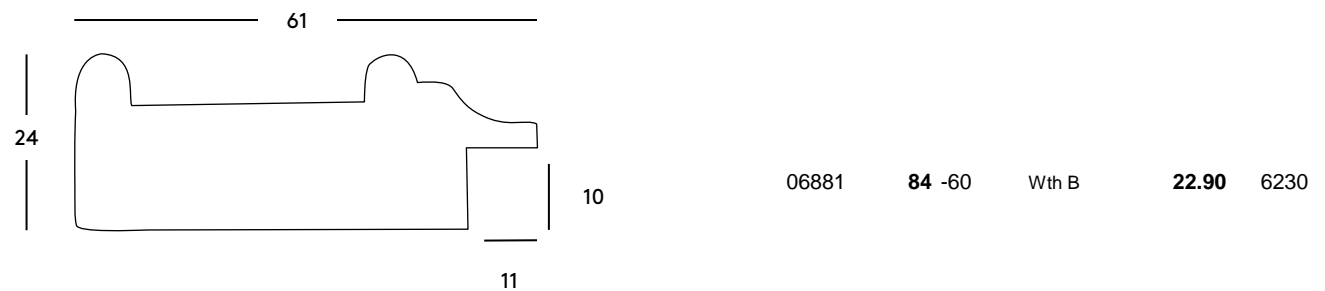
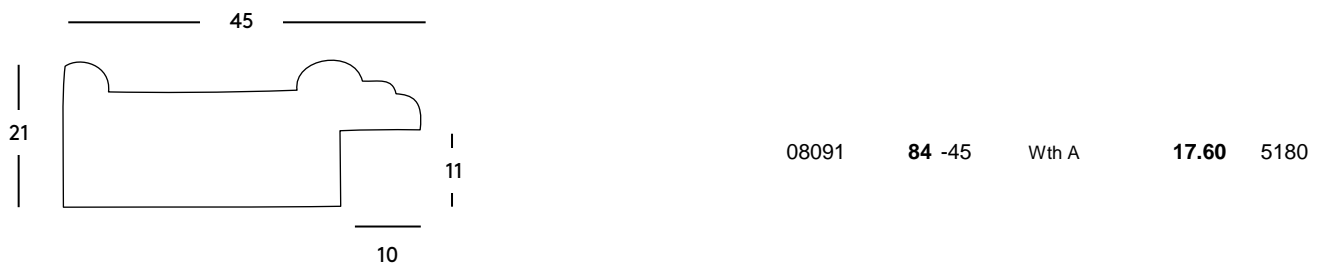
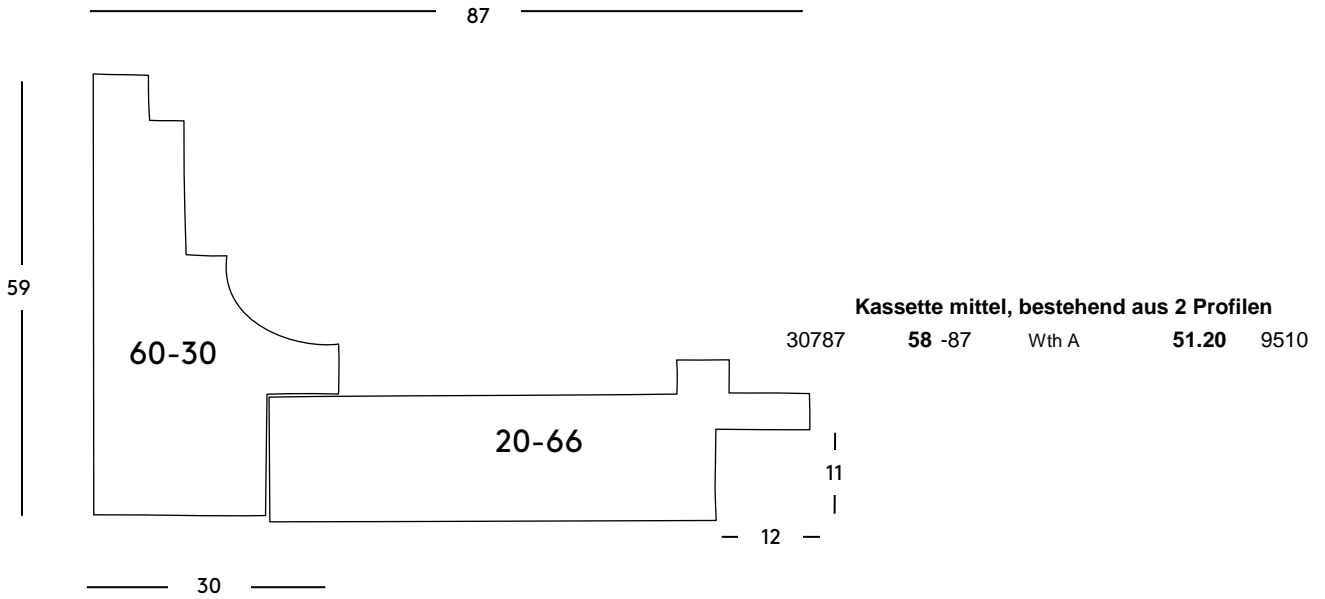

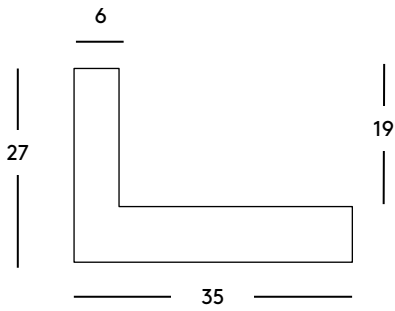

08454	220	-35/19	Linde	14.50	4150
-------	------------	--------	-------	--------------	------

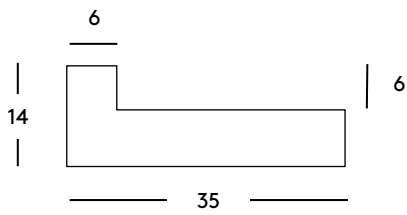

08455	221	-35/6	Linde	12.20	4130
-------	------------	-------	-------	--------------	------

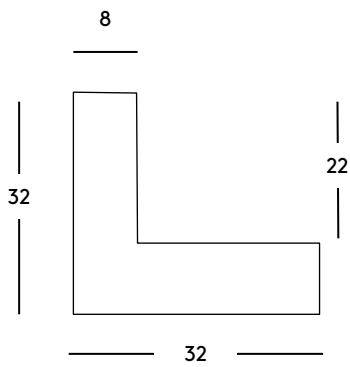

08450	235	-32/8	With A	14.50	4150
09111	235	-32/8	Fichte	14.50	4150
55262	235	-32/8	Linde	14.50	4150
09420	235	-32/8	Ahorn	23.90	4240
09412	235	-32/8	Eiche	24.90	4250
09421	235	-32/8	Nussbaum	41.30	4420
10279	235	-32/8	Grundiert	18.60	4190

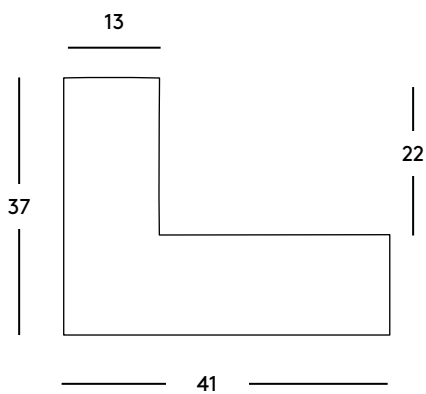

08451	238	-42/12	With A	22.90	5230
08971	238	-42/12	Fichte	24.30	5250
55265	238	-42/12	Linde	23.50	5240
22641	238	-42/12	Ahorn	34.50	5350
09413	238	-42/12	Eiche	37.20	5380
22642	238	-42/12	Nussbaum	62.80	5630
10280	238	-42/12	Grundiert	22.20	5230

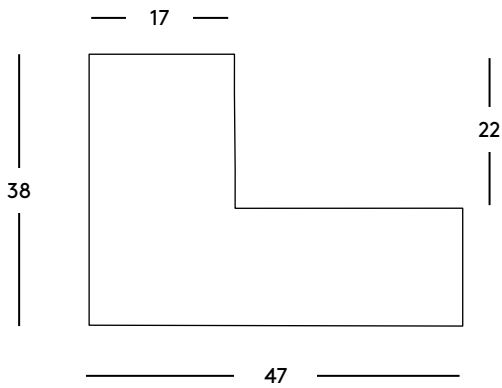

07082 **239** -47/17 With B **23.10** 5240

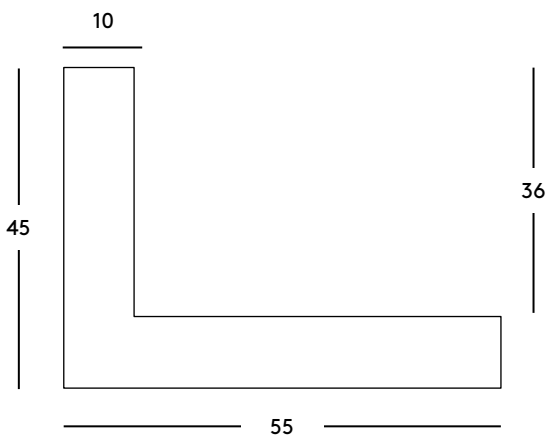

07108 **255** -45/10 Fichte **34.50** 6350
 07093 **255** -45/10 Grundiert **32.50** 6330

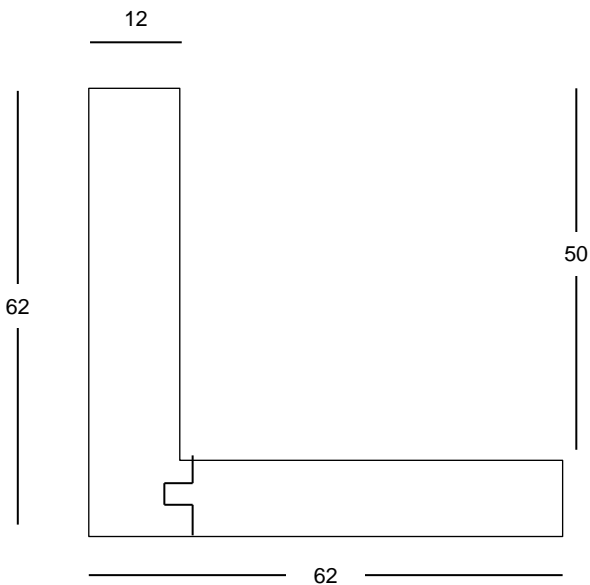

77781 **260** -62/12 Fichte **44.40** 7450

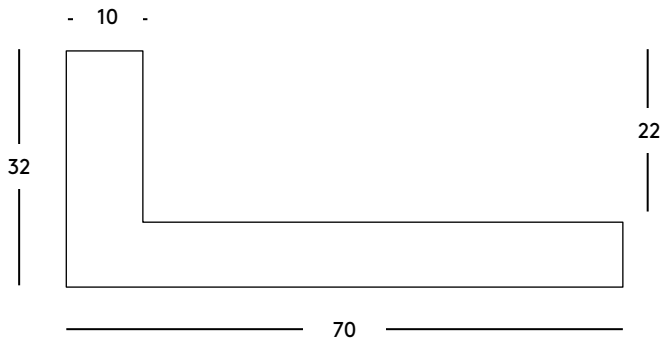

01810 **261** -70/10 Wth B **34.50** 7350

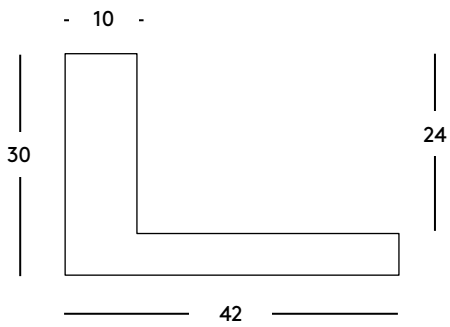

01811 **263** -42/10 Wth B **18.10** 5190

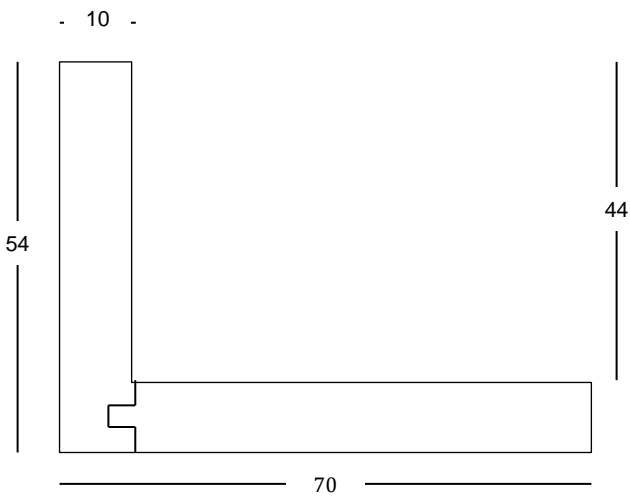

08096 **264** -70/10 Wth A **43.20** 7440

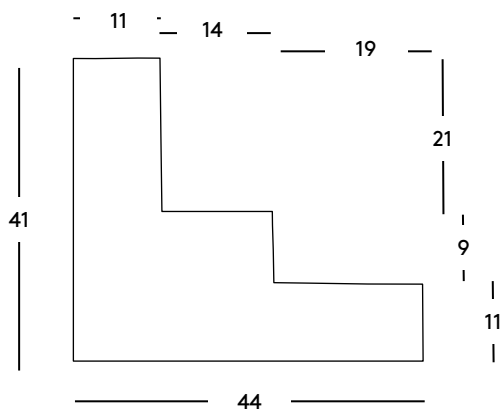

01813 **265** -44/11 Linde **23.50** 5240

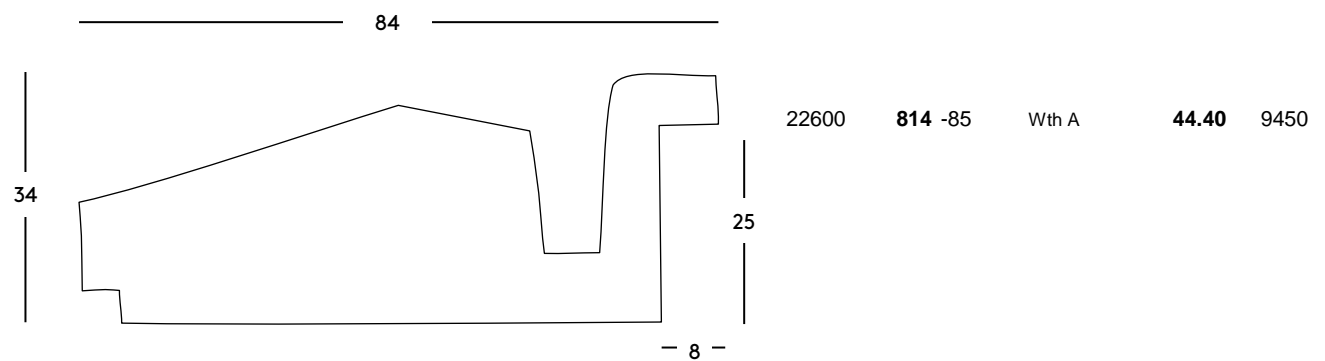
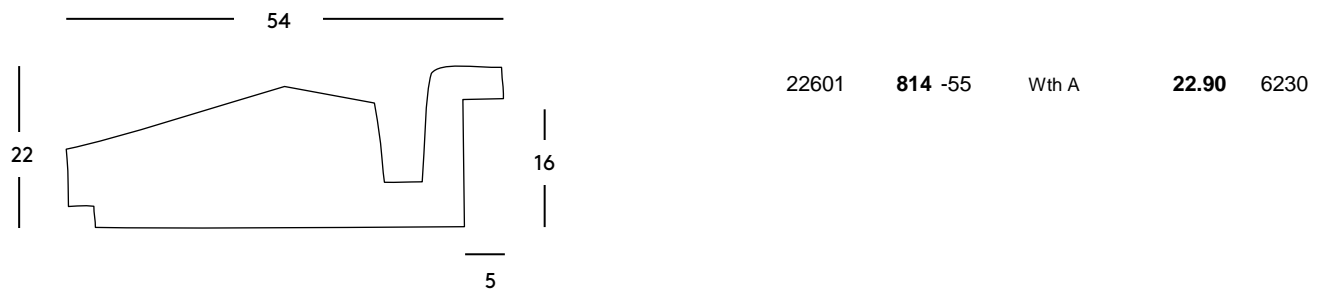
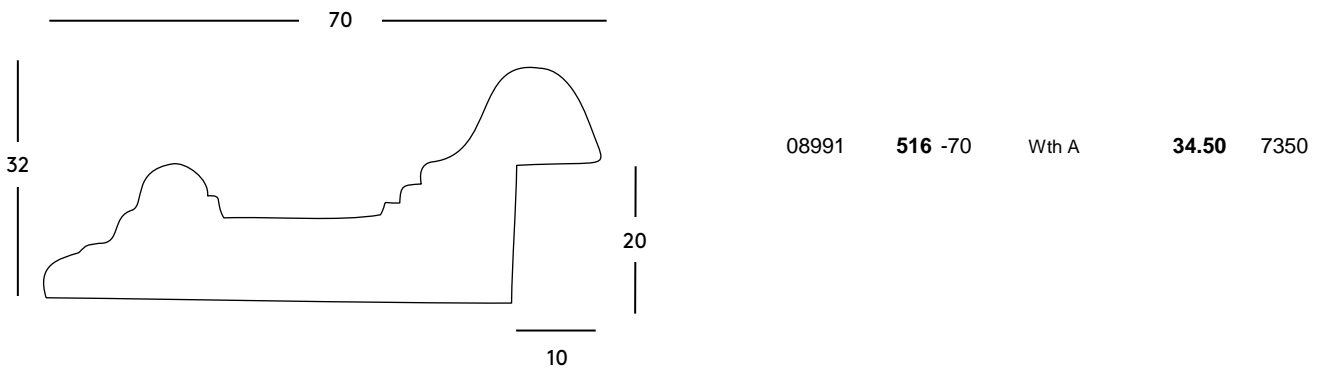
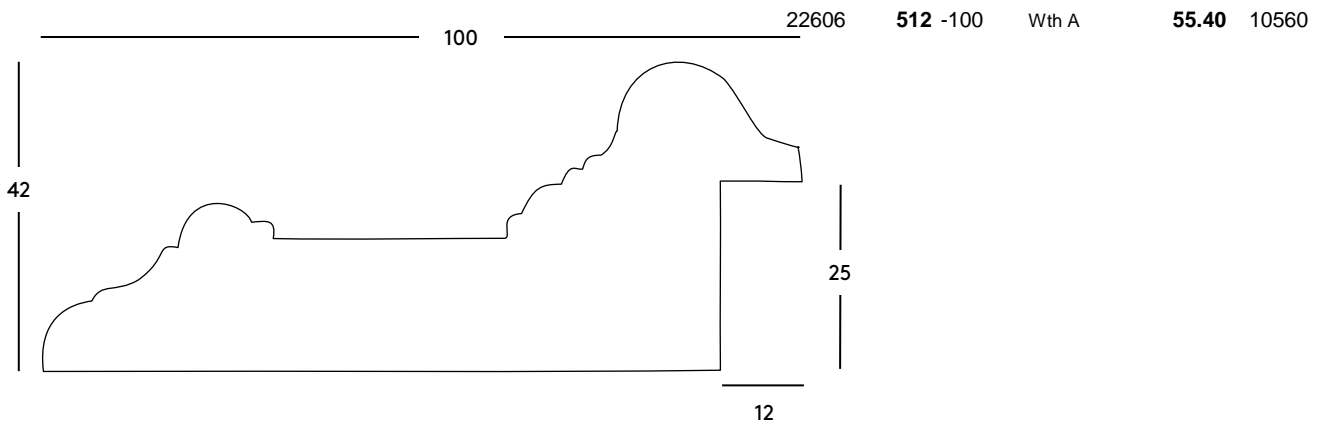

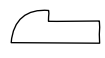
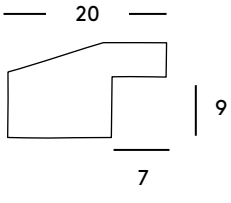
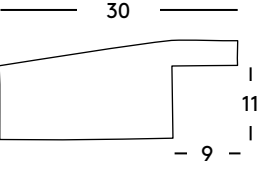
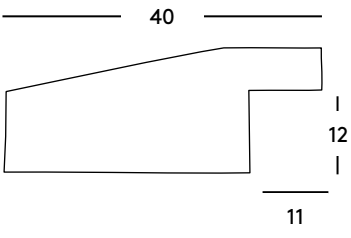
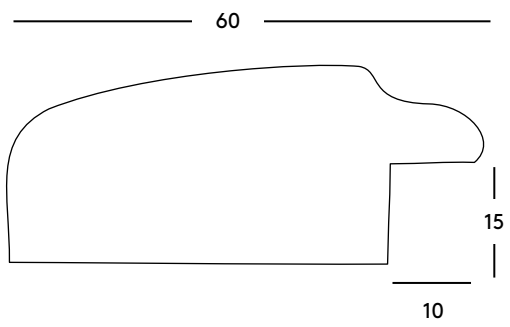
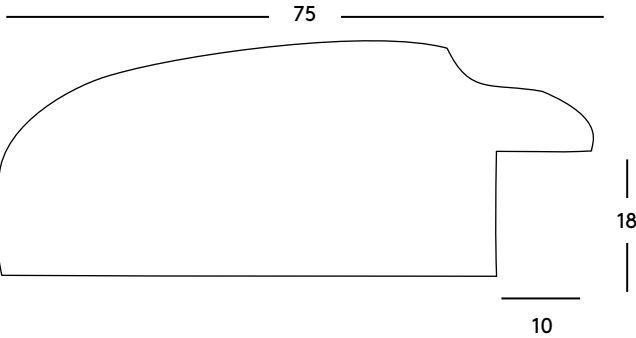
Item No.	Profile Name	Material	Price	Weight
5		Linde	7.40	280
		Wth A	9.00	290
		Wth A	13.00	3130
		Wth A	14.20	4150
		Wth B	26.70	6270
		Wth B	38.60	8390

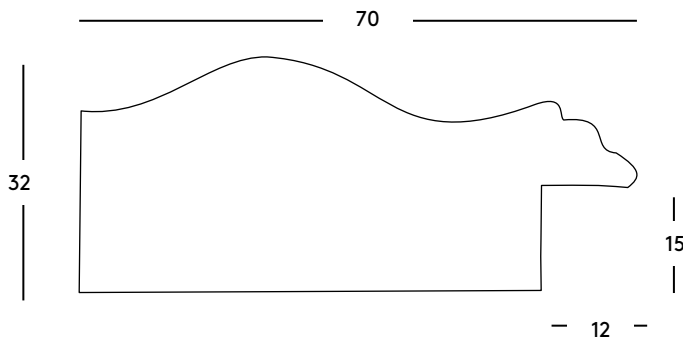

07832 **3107 -70** Wth B **34.50** 7350

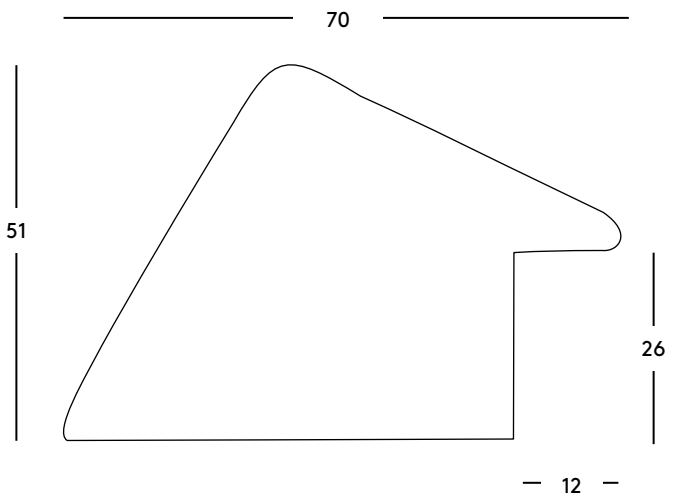

22624 **3108 -70** Wth A **44.40** 7450

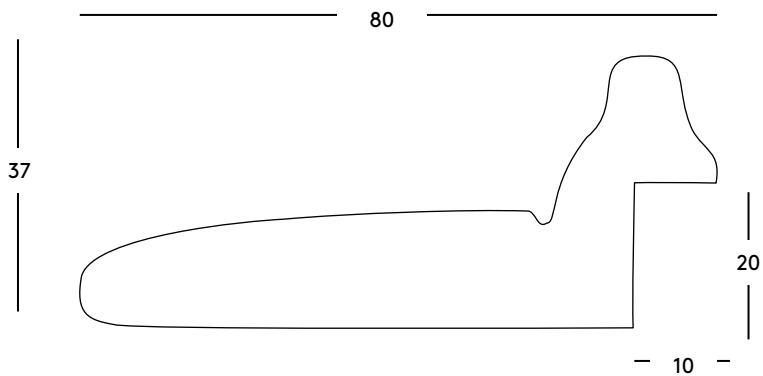

22622 **3111 -80** Wth A **43.20** 8440

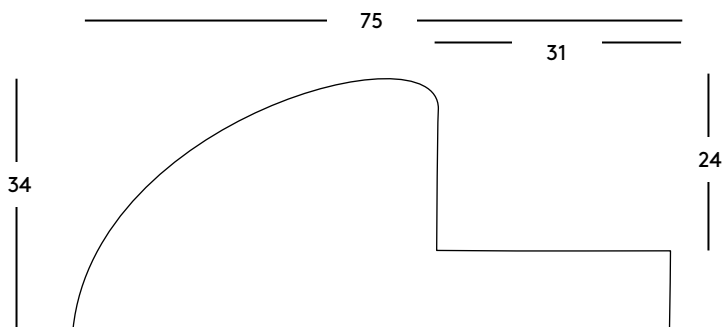

07830 **3114 -75** Wth B **38.60** 8390

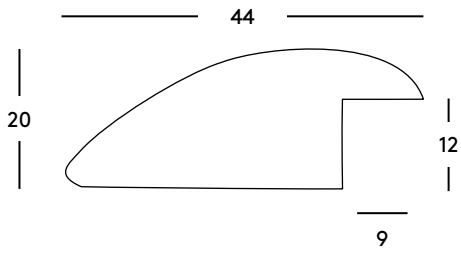

22621 **3121** -45 Wth A **14.20** 5150

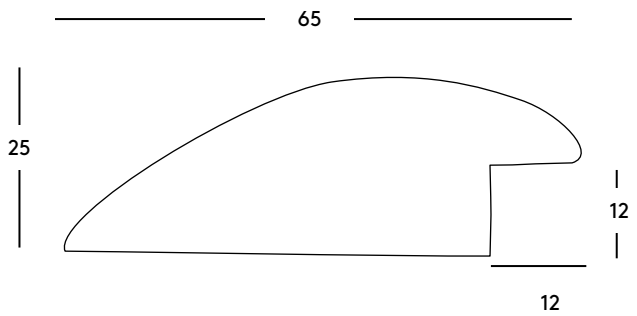

22620 **3121** -65 Wth A **26.70** 7270

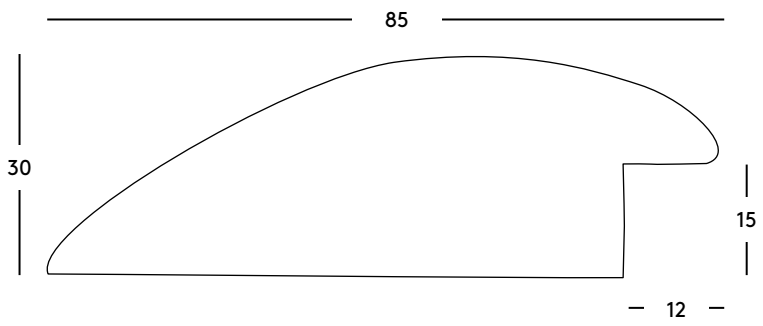

07869 **3121** -85 Wth B **38.60** 9390

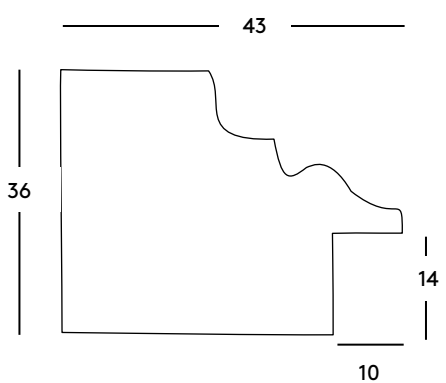

09805 **3530** -43 Wth B **22.90** 5230

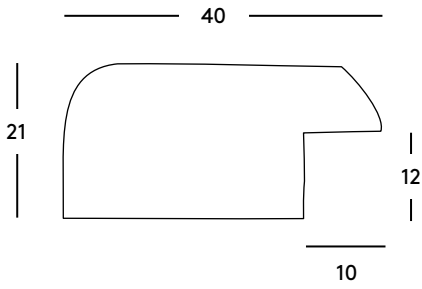

07101 **3531** -40 Wth B **14.60** 4150

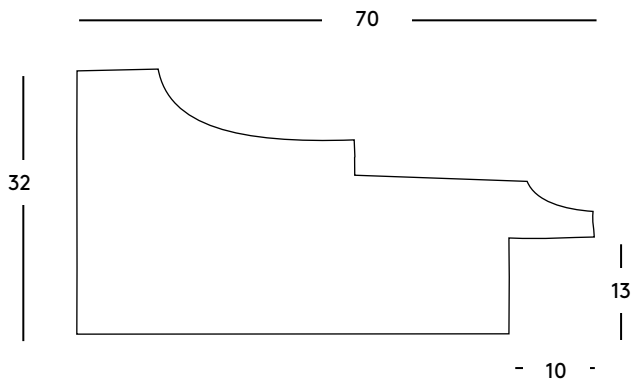

30809 **3610** -65 Wth A **34.50** 7350

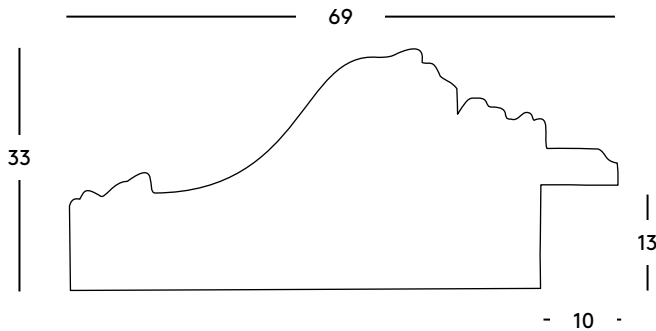

77790 **3640** -70 Ayous
mit Perlenkante **29.60** 7300

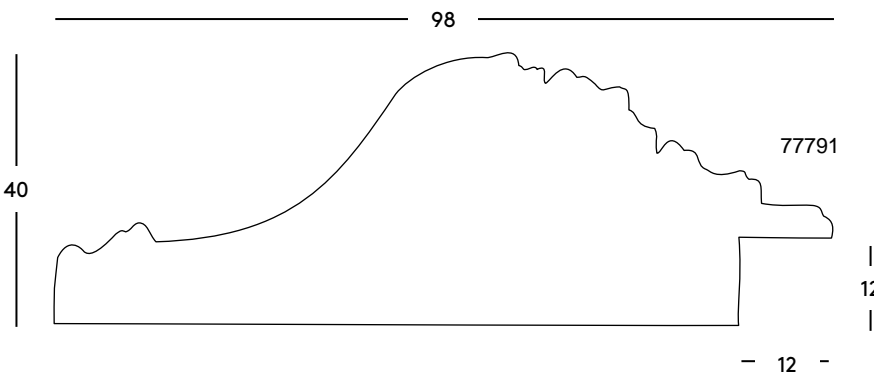

77791 **3640** -100 Ayous
mit Perlenkante **48.10** 10490



ROHLEISTEN / MASCHINENGRUNDIERTE LEISTEN

EMSA Rahmenleisten AG
Durisolstrasse 6
5612 Villmergen

056 619 10 20
info@emsa.ch
www.emsa.ch